

157 competitors from 25 nations

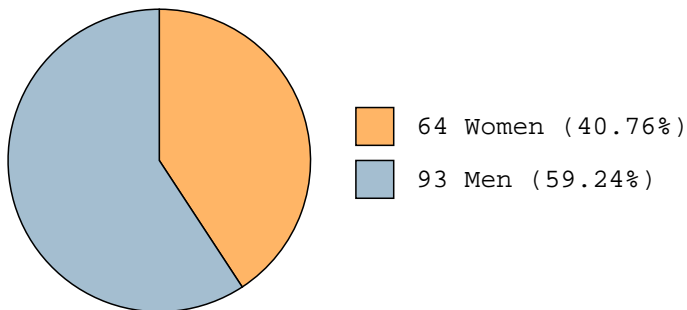

-30 kg	-34 kg	-38 kg	-42 kg	-46 kg	-50 kg	-55 kg	+55 kg	M1 -0 kg	m
10	18	21	10	7	3	5	5	14	93

-28 kg	-32 kg	-36 kg	-40 kg	-44 kg	-48 kg	-52 kg	+52 kg	F1 -0 kg	w
1	3	10	7	15	6	10	6	6	64

Continent	AJU	EJU	JUA	OJU	PJC	Total
Nations	7	16	2			25
Competitors	35	108	14			157

Schedule	day 1
Date	28 Mar
Start	
Finals	

-30 kg

1.	RUIZ FLORIT, Jose	JDK 
2.	PEREZ SANCHEZ, Derek	ALG 
3.	FERNANDEZ MUNOZ, Oliver	ELI 
3.	RIAZA DOMINGUEZ, Gines	JCC 
5.	CASTELLS HERMIDA, Pedro	VCJ 
5.	SEIJO LAGO, Gonzalo Daniel	JCA 
7.	GODOY RUGAMA, Alex Odair	JKA 
7.	GOIG LUENGO, Teiwaz Eduardo	JDK 



-34 kg

1.	MESROUK BARKA, Anas	DTO 
2.	GOMEZ MEJIA, Carlos	JDR 
3.	GIL FERNANDEZ, Jaume	KOI 
3.	TEJADA PEREZ, Luca	JCA 
5.	SHEVCHENKO., Hlib	KHA 
5.	TORTAJADA NAVARRO, Joan	JCC 
7.	SALVADOR LORENTE, Lucas	KOI 
7.	VILAPLANA JIMENEZ, Alejandro	JCA 







-38 kg

1.	VILLENA GOMEZ, Rodrigo	VCJ 
2.	GRAU CARPIO, Pedro	HER 
3.	BARTIUK., Nazar	KHA 
3.	KWIT., Karol	TOR 
5.	MARTIN CREMADES, Pablo	ALG 
5.	ROMERO PERIS, Eduardo	REQ 
7.	GRYGORIAN., Georgii	KHA 
7.	ORTS GOMEZ, Guillem	JKA 



-42 kg

1.	PEREZ GRAU, Hugo	VCJ 
2.	GIL SORIANO, Carlos	JCC 
3.	ESPINOSA VILASECA, Alejandro	JKA 
3.	PANACH FULGENCIO, Marc	JKA 
5.	DE PEDRO PLA, Fernando	CHI 
5.	RODRIGUEZ CUBELLS, Diego	JKA 
7.	GUZENKO., Roman	KOI 
7.	KAMORKIN., Danylo	KHA 





-46 kg

1.	SANGUESA LOPEZ, Mario	KOI 
2.	SAHAKYAN., Alex	JCC 
3.	KHARUZENKA., Mikita	KHA 
3.	STENKO., Roman	CHI 
5.	BIELIAKOV., Hlib	KHA 
5.	DAWSON MORA, Seyram Diego	CAS 
7.	CRESPO VELA, Diego	VCJ 
7.		



-50 kg

1.	MONTOYA HERNANDEZ, Hugo	JDR 
2.	AGUDO ALMAZAN, Ares	HER 
3.	GARCIA IONESCU, Izan Nicolas	KOI 
3.		
5.		
5.		
7.		
7.		

-55 kg

1.	MELIA, Hugo	GIL 
2.	LOPEZ VAZQUEZ, Marcos	JCA 
3.	HIDALGO NADAL, Hugo	EJC 
3.	ORTEGA BURGUERA, Pau	RON 
5.	PASTOR COMPANY, Pau	JDK 
5.		
7.		
7.		

+55 kg

1.	GAMBOA BAVIERA, Javier	HER 
2.	FENOLL URENDA, Sergio	KOI 
3.	DIAZ FERNANDEZ, Marc	JCA 
3.	VAREA LORENTE, Gonzalo	REQ 
5.	MANZANO MARTINEZ, Raul	JDK 
5.		
7.		
7.		



M1 -0 kg

1.		
2.		
3.		
3.		
5.		
5.		
7.		
7.		

-28 kg

1.	ALANZABE HERNANDEZ, Noa	VCJ	
2.			
3.			
3.			
5.			
5.			
7.			
7.			

-32 kg

1.	PARRA GREGORI, Valentina	BEN	
2.	ALONSO GUTIERREZ, Iara	JCC	
3.	ALANZABE HERNANDEZ, Noa	VCJ	
3.			
5.			
5.			
7.			
7.			

-36 kg

1.	BURGOS BALLESTER, Rosita	ELI	
2.	SALES SOLA, Laia	KOI	
3.	MILANA ., Danh	KHA	
3.	VANKERCKHOVEN FERNANDEZ, Daniella	JCC	
5.	CANADA SALES, Dafne	JCC	
5.	DROBENKO ., Anastasiia	KHA	
7.	MARINA MATEI , Sara	VCJ	
7.	SEIJO LAGO, Carmen	JCA	

-40 kg

1.	GARCIA FERNANDEZ, Miranda	KOI	
2.	MONTESINOS MARCO, Daniela	JCC	
3.	GARRIDO CORTES, Paula	JKA	
3.	ZORRILLA PASTOR, Valentina	GIL	
5.	DASCALESCU ., Ariana Veronica	JCC	
5.	MARTINEZ FERRIZ, Isabel	JSC	
7.	GASCON DEL TORO, Triana	OBI	
7.			

-44 kg

1.	JOYA SEGURA, Elisa	KOI	
2.	LOPEZ DE LA FUENTE, Aitana	JCC	
3.	CREVILLEN BALLESTER, Rebeca	JDK	
3.	GARCIA BLAYA, Elena	JDK	
5.	CARBONELL AVILA, Ariadna	JKA	
5.	COSTA SANCHO, Mireia	ELI	
7.	LLACER GIL, Carlie	JRV	
7.	MARTINEZ RIVAS, Sara	JKA	

-48 kg

1.	LACASA PEREZ, Vega	GIL	
2.	CASTRO AVILA, Carla	JCA	
3.	AGUIAR SALDANA, Aylin Samanta	VCJ	
3.	SERNA GOMEZ, Monica	OBI	
5.	AITANA NAVARRO, Tanesi	VCJ	
5.	SANCHEZ AMAT, Lucia	CHI	
7.			
7.			

-52 kg

























1.	DIAZ TORRICO, Barbara Lucia	JRV	
2.	LIN , Yuhuan	JDK	
3.	O NEILL GONZALEZ, Alice	CAS	
3.	O NEILL GONZALEZ, Julia	CAS	
5.	PLAZA FERNANDEZ, Nayara	JSC	
5.	QUILIS SAVASTRE, Elena	VCJ	
7.	CRESPO CERRATO, Alejandra	VCJ	
7.	RUIZ DIEZ, Emma	KOI	

+52 kg

1.	SATASH ., Laura	KHA	
2.	BURDEUS RUGER, Aitana	JCC	
3.	NAVARRETE GEA, Noa	JCA	
3.	SALAS MAURI, Andrea	ELI	
5.	BAILEN LOPEZ, Blanca	JCA	
5.	GUO ., Qiming	JCA	
7.			
7.			

F1 -0 kg

1.		
2.		
3.		
3.		
5.		
5.		
7.		
7.		

				1st place	2nd place	3rd place	5th place	7th place
1.		KOI	Club De Judo Koi	3	2	2	0	3
2.		VCJ	Valencia Club De Judo	3	0	2	3	3
3.		GIL	Club Judo Gilet	2	0	1	0	0
4.		HER	Club Herca	1	2	0	0	0
5.		JDK	Club Judokan Valencia	1	1	2	2	1
6.		JDR	C. J. Judokan Riba Roja De Turia	1	1	0	0	0
7.		KHA	Khalmatov Judo	1	0	3	3	2
8.		ELI	C.J. L Eliana	1	0	2	1	0
9.		JRV	Judo Club Rochela Valencia	1	0	0	0	1
10.		BEN	Benetusser Club Judo	1	0	0	0	0
10.		DTO	Distrito 10	1	0	0	0	0
12.		JCC	J.C. Canet		6	2	3	0
13.		JCA	Judo Club Alicante		2	3	3	2
14.		ALG	C.D. Algar		1	0	1	0
15.		JKA	Club Judo Judokan Alboraya			3	2	3
16.		CAS	Club Judo Castalla			2	1	0
17.		CHI	Club Judo Chidaoba			1	2	0
18.		REQ	Judo Club Requena			1	1	0
19.		OBI	Obi Formentera			1	0	1
20.		EJC	Judo Club Cocentaina			1	0	0
20.		RON	C.D. Ronin			1	0	0
20.		TOR	J.C. Torrevieja			1	0	0
23.		JSC	Judo Sara Conejero				2	0
24.		ALB	Judo Club Albal					
24.		SJO	Club De Judo Flox Sant Joan					







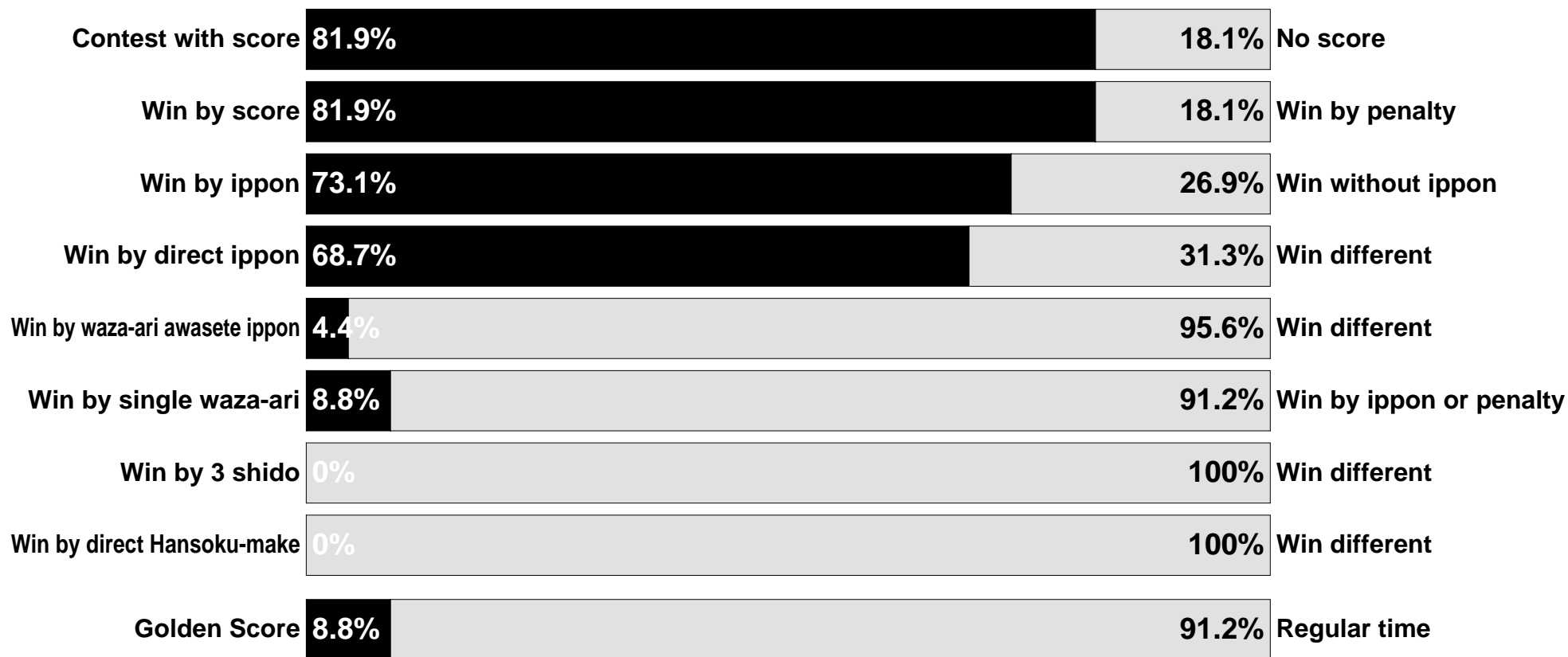

















25 nations in this event

25 nations with places 1st-7th (= 100%)

22 nations with medals (= 88%)



	-30 kg	-34 kg	-38 kg	-42 kg	-46 kg	-50 kg	-55 kg	+55 kg	M1 -0 kg	-28 kg	-32 kg	-36 kg	-40 kg	-44 kg	-48 kg	-52 kg	+52 kg	F1 -0 kg	Men	Women	T
Competitors	10	18	21	10	7	3	5	5	14	1	3	10	7	15	6	10	6	6	93	64	
Contests	13	25	30	13	9	3	6	6			3	15	9	21	7	15	7		105	77	
Contests with positive score	11	20	21	10	7	3	5	6			3	11	6	18	7	14	7		83	66	
Contests with positive score %	84.6%	80%	70%	76.9%	77.8%	100%	83.3%	100%			100%	73.3%	66.7%	85.7%	100%	93.3%	100%		79%	85.7%	8
Wins by positive score	11	20	21	10	7	3	5	6			3	11	6	18	7	14	7		83	66	
Wins by positive score %	84.6%	80%	70%	76.9%	77.8%	100%	83.3%	100%			100%	73.3%	66.7%	85.7%	100%	93.3%	100%		79%	85.7%	8
Wins by Ippon	10	16	19	9	6	3	4	6			3	10	5	17	5	13	7		73	60	
Wins by Ippon %	76.9%	64%	63.3%	69.2%	66.7%	100%	66.7%	100%			100%	66.7%	55.6%	81%	71.4%	86.7%	100%		69.5%	77.9%	7
Wins by Waza-ari awasete Ippon	1	2	3		1										1				7	1	
Wins by Waza-ari awasete Ippon %	7.7%	8%	10%	0%	11.1%	0%	0%	0%			0%	0%	0%	0%	14.3%	0%	0%		6.7%	1.3%	4
Wins by waza-ari	1	4	2	1	1		1					1	1	1	2	1			10	6	
Wins by waza-ari %	7.7%	16%	6.7%	7.7%	11.1%	0%	16.7%	0%			0%	6.7%	11.1%	4.8%	28.6%	6.7%	0%		9.5%	7.8%	8
Waza-ari	1	6	5	1	1		1					1	2	2	3	1			15	9	
Positive Scores	12	24	27	10	8	3	5	6			3	11	7	19	9	14	7		95	70	
Average positive Scores	0.9	1	0.9	0.8	0.9	1	0.8	1			1	0.7	0.8	0.9	1.3	0.9	1		0.9	0.9	
Shido		3					1	2				2	1				1		6	4	
Average shido per contest	0	0.1	0	0	0	0	0.2	0.3			0	0.1	0.1	0	0	0	0.1		0.1	0.1	
Wins by 3 shido for opponent																					
Wins by 3 shido for opponent %	0%	0%	0%	0%	0%	0%	0%	0%			0%	0%	0%	0%	0%	0%	0%		0%	0%	
Direct Hansoku-make																					
Direct HSKM (Out of tournament)																					
Golden Score	3	2	3	2	1		1	1				2					1		13	3	
Golden Score %	23.1%	8%	10%	15.4%	11.1%	0%	16.7%	16.7%			0%	13.3%	0%	0%	0%	0%	14.3%		12.4%	3.9%	8
Osae-komi	3	5	15	6	5	1	3	2			2	15	5	14	2	10	2		40	50	

				-30	-34	-38	-42	-46	-50	-55	+55	M1-0	m	-28	-32	-36	-40	-44	-48	-52	+52	F1-0	w	total	
1.		ALB	Judo Club Albal			1							1											0	1
2.		ALG	C.D. Algar	1		1							2											0	2
3.		BEN	Benetusser Club Judo										0		1									1	1
4.		CAS	Club Judo Castalla			1		1					2			1				2				3	5
5.		CHI	Club Judo Chidaoba		1	1	1	1					2	6					1			1		2	8
6.		DTO	Distrito 10		1								1											0	1
7.		EJC	Judo Club Cocentaina							1		1	2											0	2
8.		ELI	C.J. L Eliana	2		1							3			1		1			1			3	6
9.		GIL	Club Judo Gilet							1			1				1	1						2	3
10.		HER	Club Herca			1			1		1		3											0	3
11.		JCA	Judo Club Alicante	1	2		1			1	1	1	7			1		1	1	3				6	13
12.		JCC	J.C. Canet	1	1		1	1				1	5		1	2	2	1			1	1		8	13
13.		JDK	Club Judokan Valencia	2	3	5				1	1	5	17			1		2		1				4	21
14.		JDR	C. J. Judokan Riba Roja De Turia		1				1				2									1		1	3
15.		JKA	Club Judo Judokan Alboraya	1	2	2	4						9				1	6						7	16
16.		JRV	Judo Club Rochela Valencia										0					1		1				2	2
17.		JSC	Judo Sara Conejero										0				1			2				3	3
18.		KHA	Khalmatov Judo	1	2	2	1	2				2	10			2					1	2		5	15
19.		KOI	Club De Judo Koi		2	1	1	1	1		1		7			1	1	1		1				4	11
20.		OBI	Obi Formentera									1	1				1	1	1					3	4
21.		REQ	Judo Club Requena		1	1					1		3											0	3
22.		RON	C.D. Ronin							1			1											0	1
23.		SJO	Club De Judo Flox Sant Joan									1	1									1		1	2
24.		TOR	J.C. Torrevieja			1							1											0	1
25.		VCJ	Valencia Club De Judo	1	2	3	1	1					8	1	1	1		2	2	2				9	17
				10	18	21	10	7	3	5	5	14	93	1	3	10	7	15	6	10	6	6	6	64	157

Campeonato Autonómico de Judo Alevin Valencia 2026

Polideportivo UPV (FVJ), 28 Mar 2026

-30 kg

10 Judoka

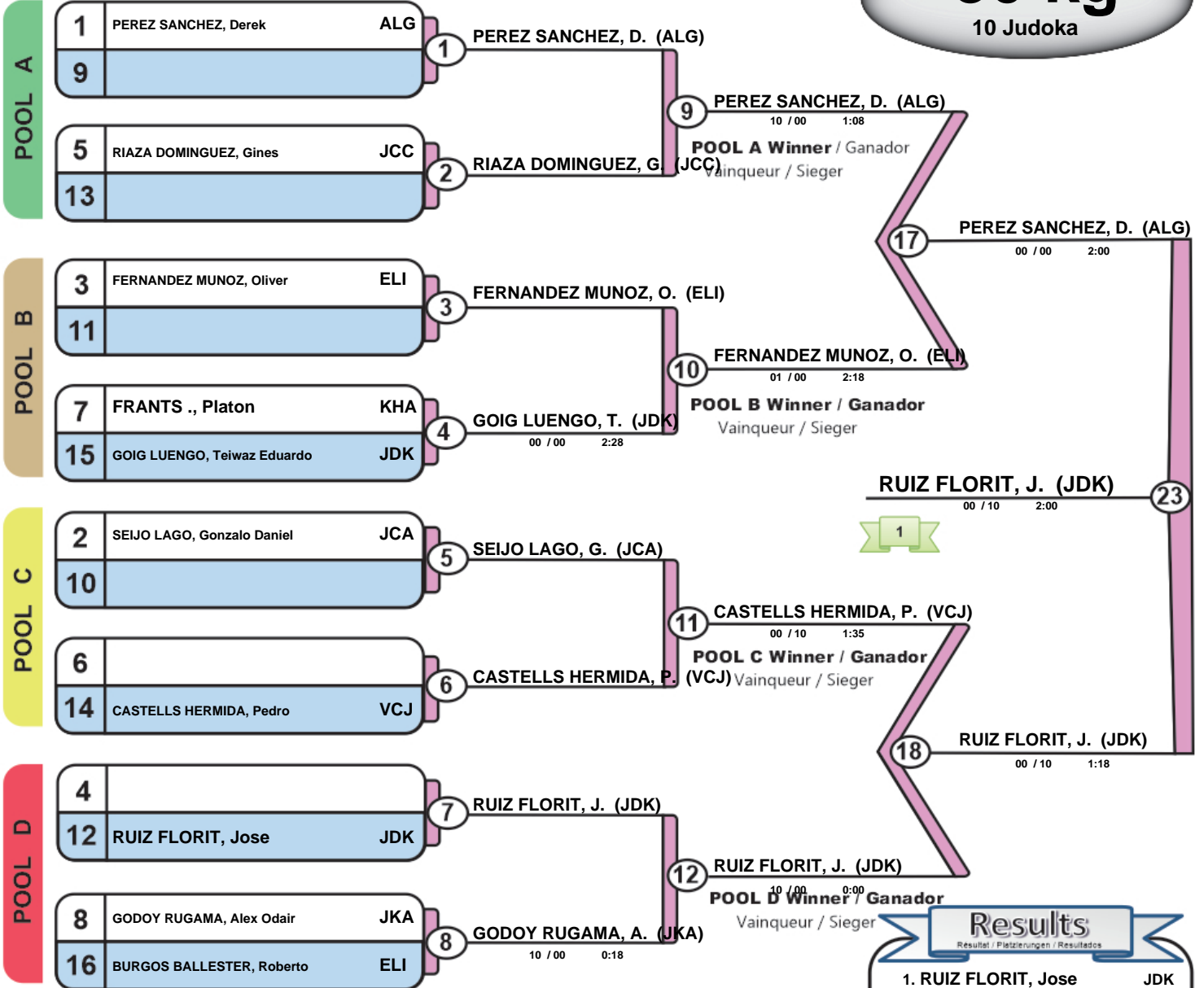

Trostrunde / Repechage / Ronda de consolación

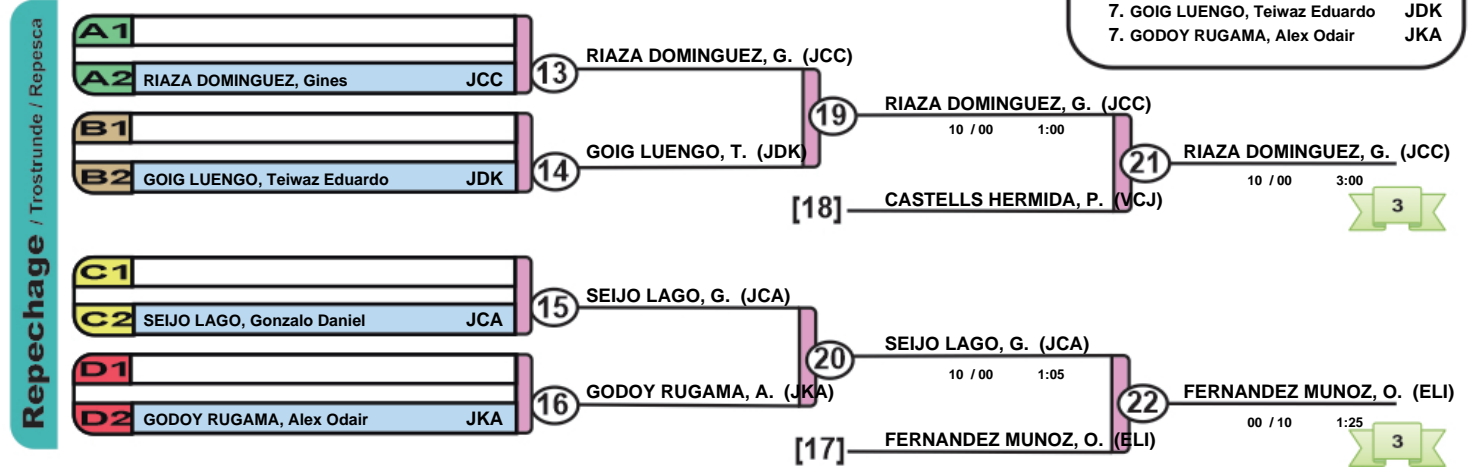

Campeonato Autonómico de Judo Alevin Valencia 2026

Polideportivo UPV (FVJ), 28 Mar 2026

-34 kg

18 Judoka

POOL A

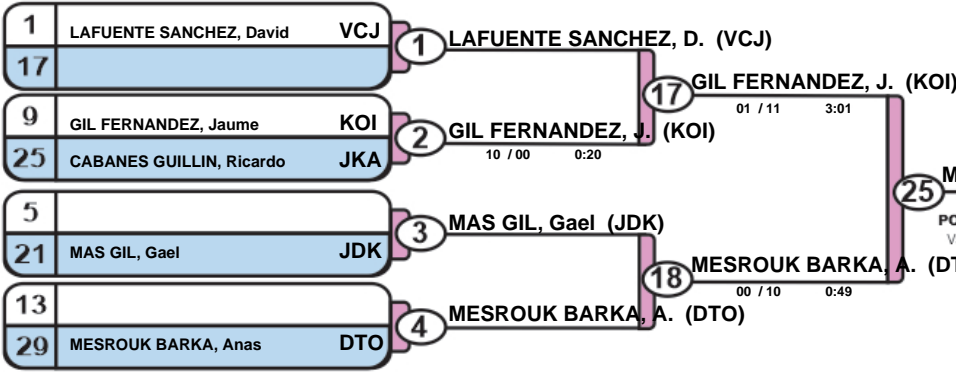

POOL B

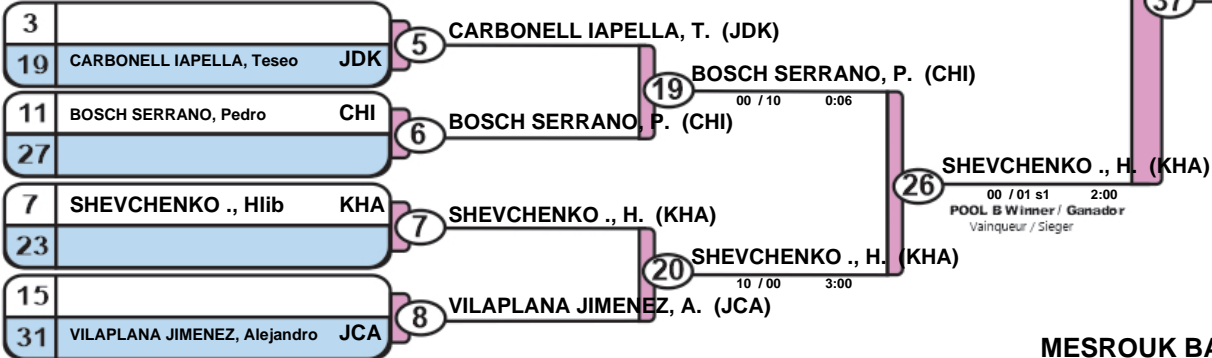

POOL C

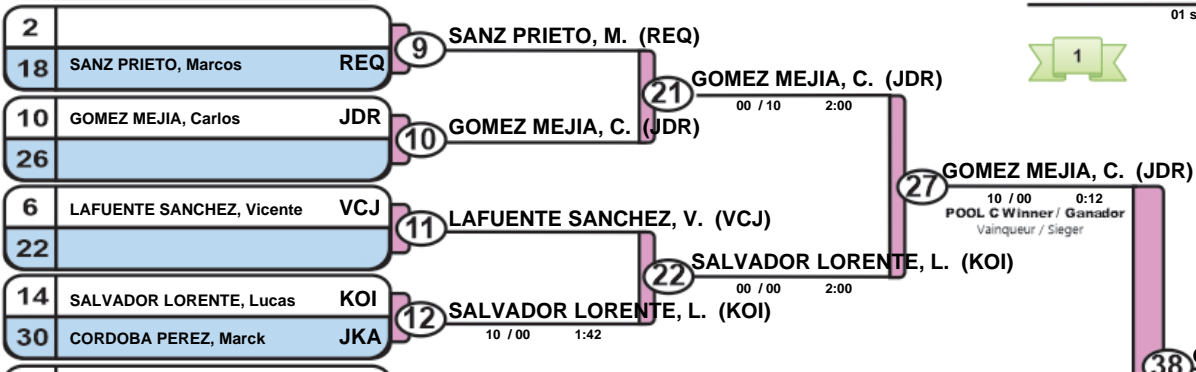

POOL D

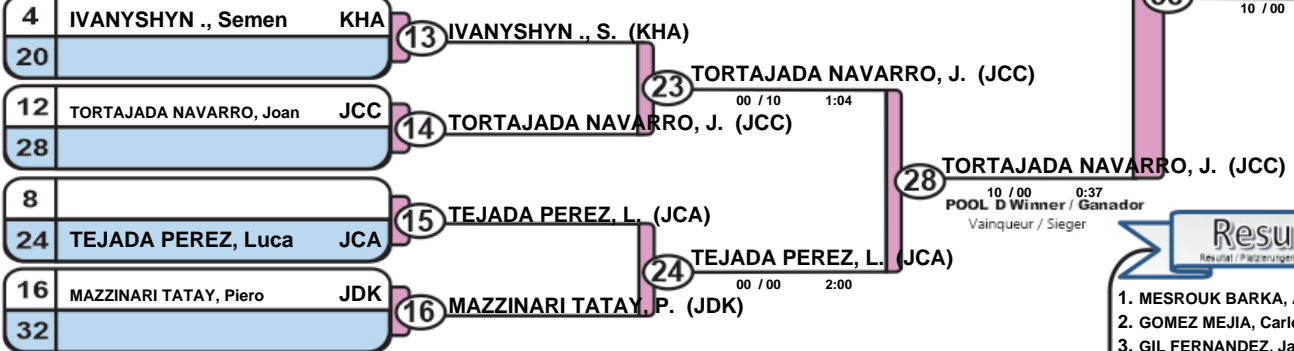

MESROUK BARKA, A. (DTO) 43



Results
Resultat / Platzierungen / Resultados

- MESROUK BARKA, Anas DTO
- GOMEZ MEJIA, Carlos JDR
- GIL FERNANDEZ, Jaume KOI
- TEJADA PEREZ, Luca JCA
- TORTAJADA NAVARRO, Joan JCC
- VILAPLANA JIMENEZ, Alejandro JCA
- SALVADOR LORENTE, Lucas KOI

Repechage / Trostrunde / Repechage

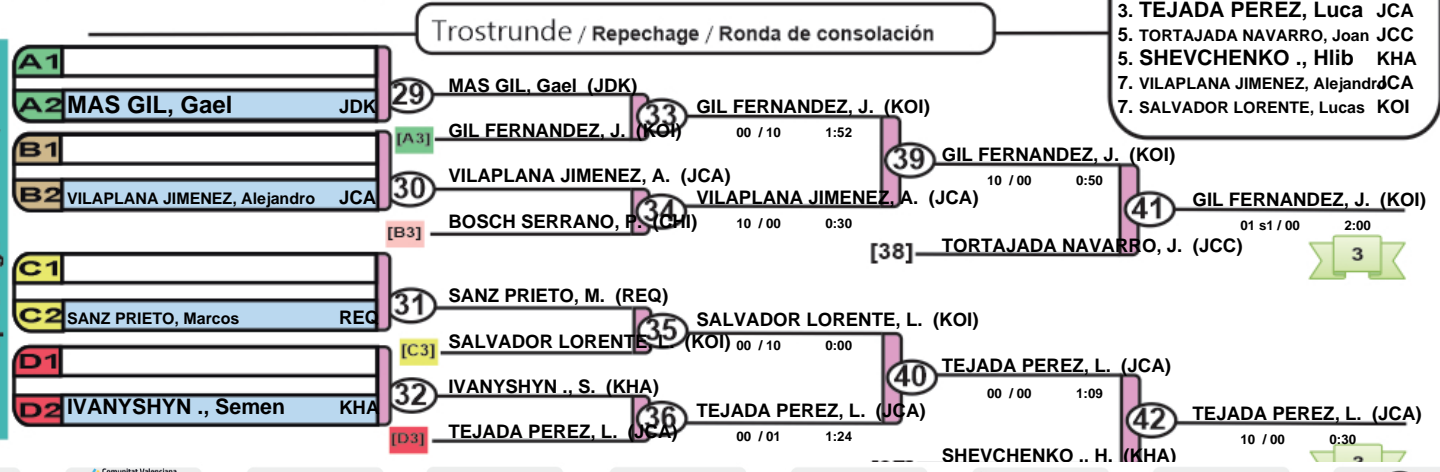

Campeonato Autonómico de Judo Alevin Valencia 2026

Polideportivo UPV (FVJ), 28 Mar 2026

-38 kg

21 Judoka

POOL A

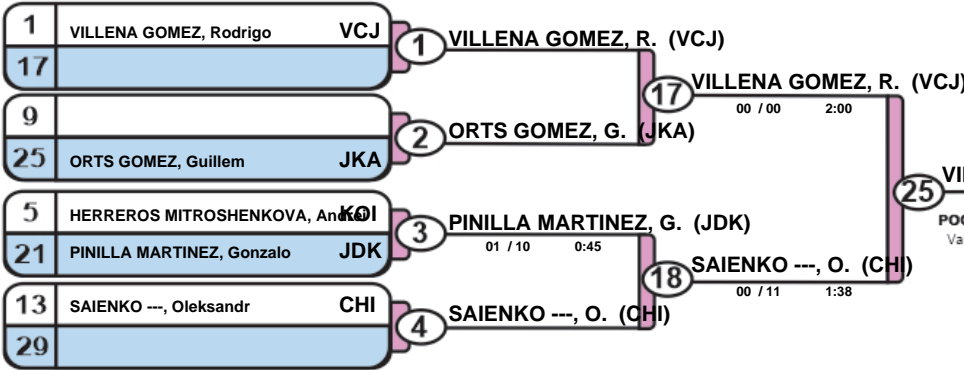

POOL B

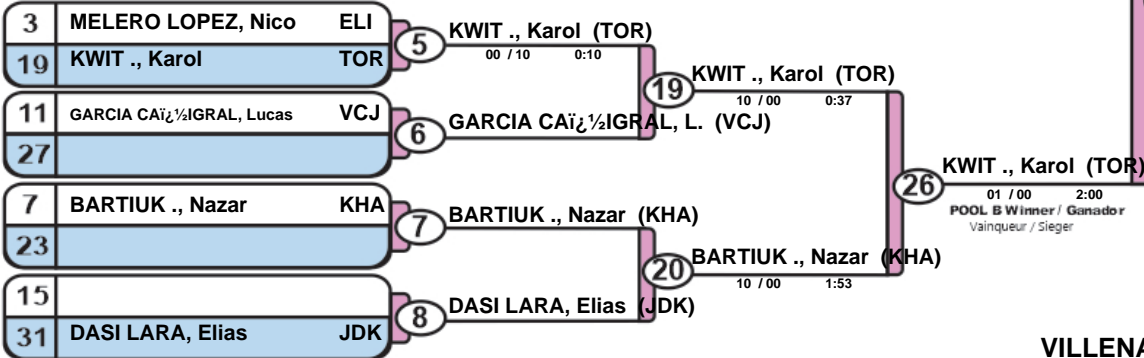

POOL C

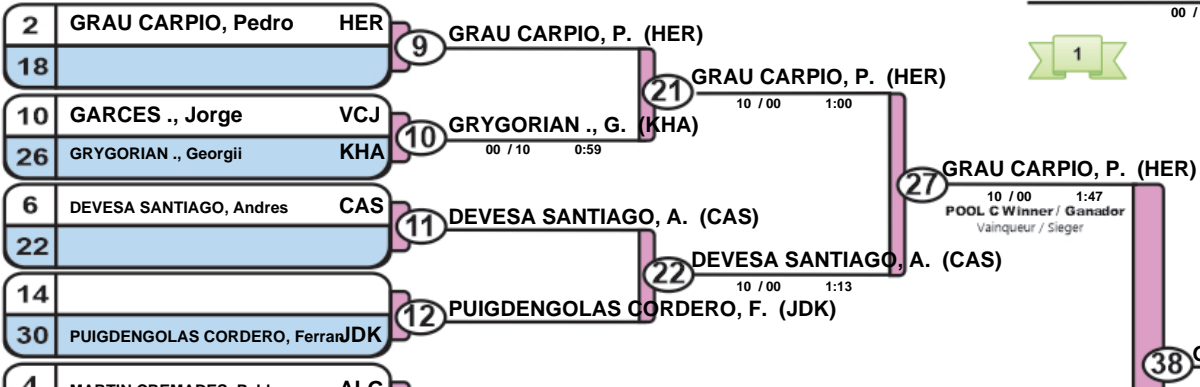

POOL D

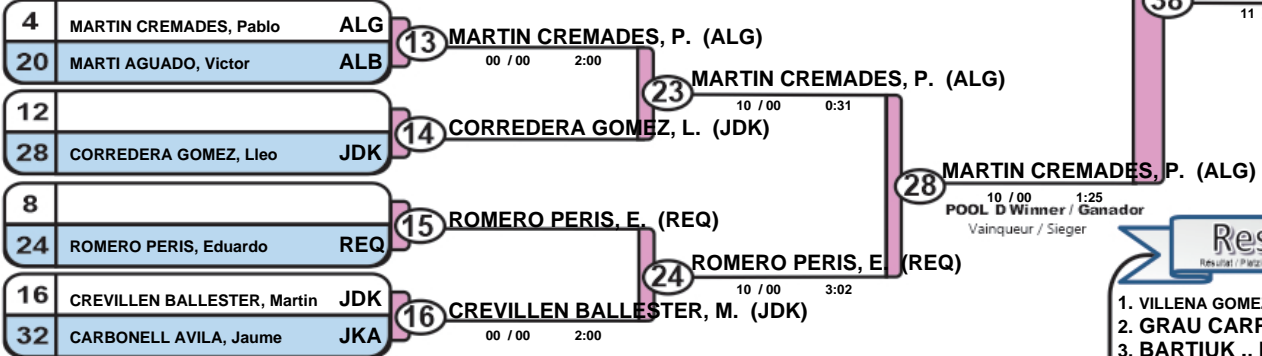

VILLENA GOMEZ, R. (VCJ) 43



Results

Resultat / Platzierung / Resultados

- VILLENA GOMEZ, Rodrigo VCJ
- GRAU CARPIO, Pedro HER
- BARTIUK ., Nazar KHA
- KWIT ., Karol TOR
- MARTIN CREMADES, Pablo ALG
- ROMERO PERIS, Eduardo REQ
- ORTS GOMEZ, Guillem JKA
- GRYGORIAN ., Georgii KHA

Trostrunde / Repechage / Ronda de consolación

Repechage / Trostrunde / Repechage

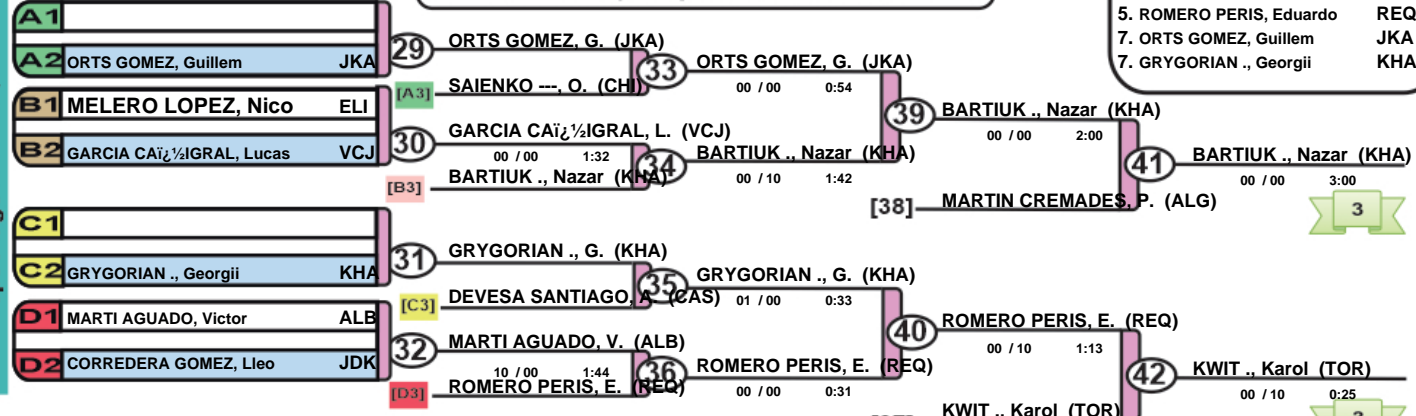

Campeonato Autonómico de Judo Alevin Valencia 2026

Polideportivo UPV (FVJ), 28 Mar 2026

-42 kg

10 Judoka

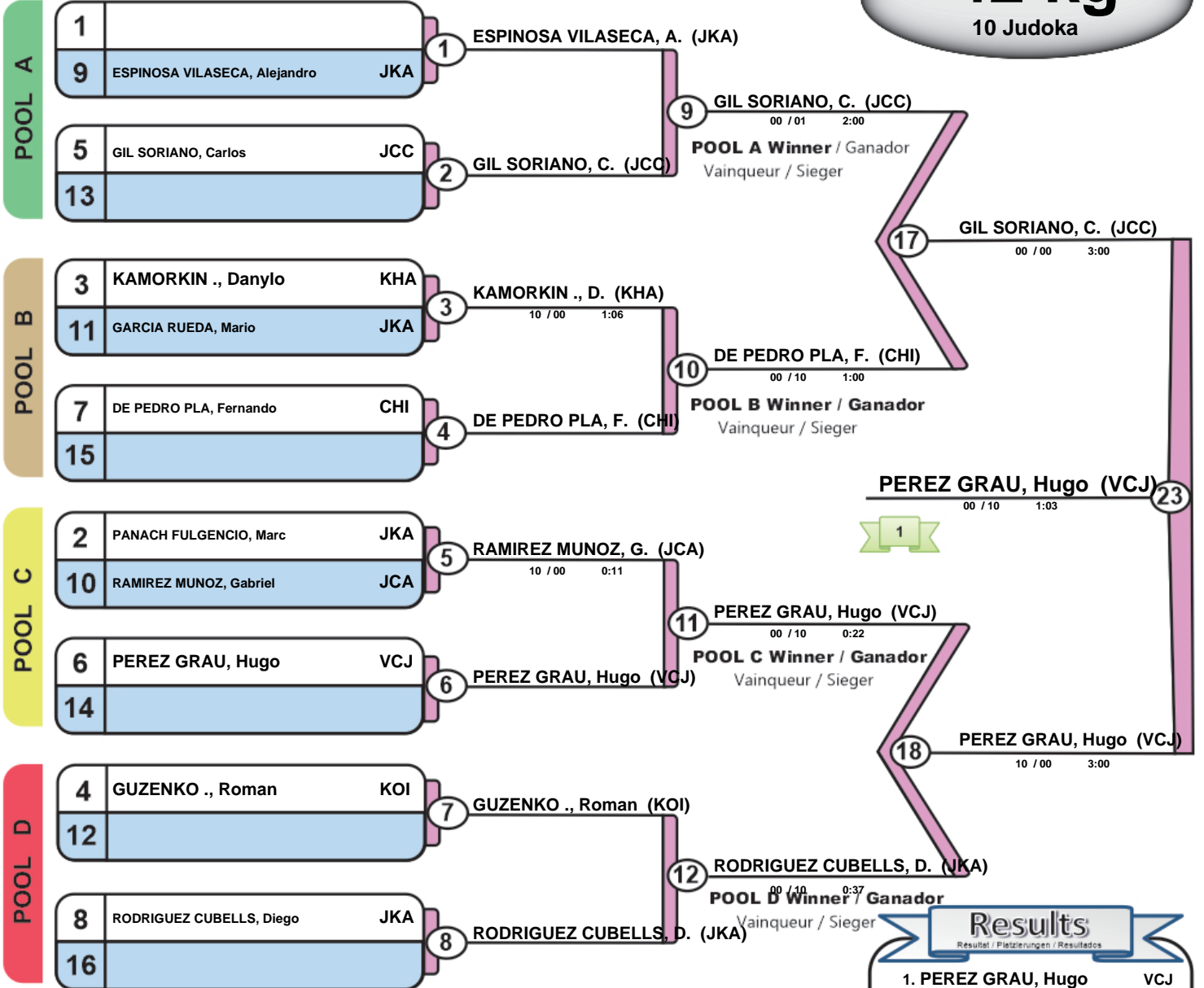

Results
 Resultat / Platzierungen / Resultados

1. PEREZ GRAU, Hugo	VCJ
2. GIL SORIANO, Carlos	JCC
3. ESPINOSA VILASECA, Alejandro	JKA
3. PANACH FULGENCIO, Marc	JKA
5. RODRIGUEZ CUBELLS, Diego	JKA
5. DE PEDRO PLA, Fernando	CHI
7. KAMORKIN., Danylo	KHA
7. GUZENKO., Roman	KOI

Trostrunde / Repechage / Ronda de consolación

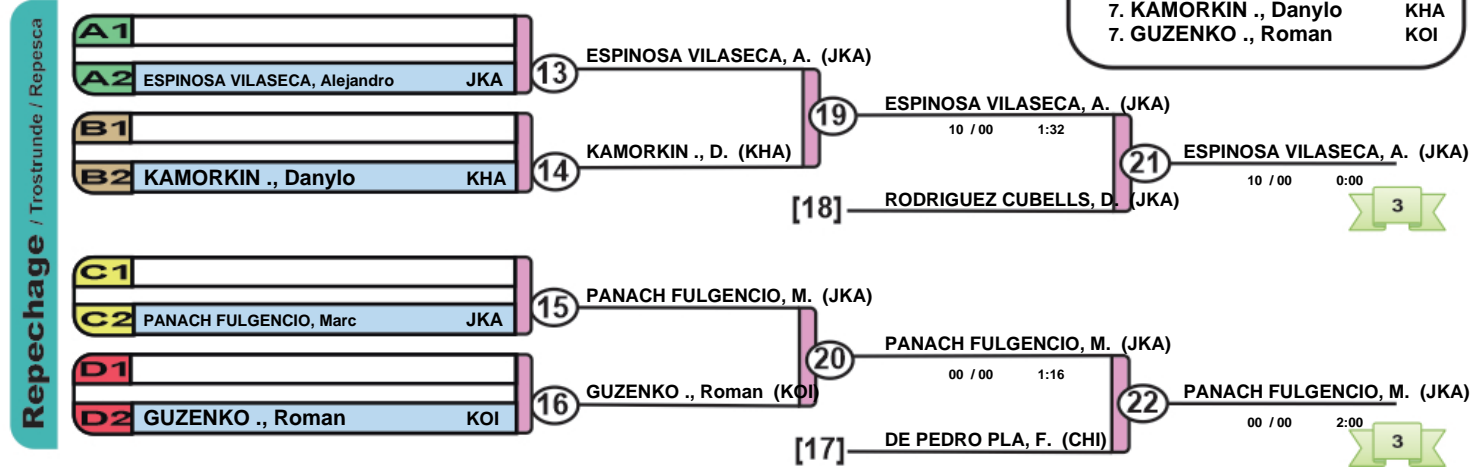



Campeonato Autonómico de Judo Alevin Valencia 2026

Polideportivo UPV (FVJ), 28 Mar 2026

-46 kg

7 Judoka

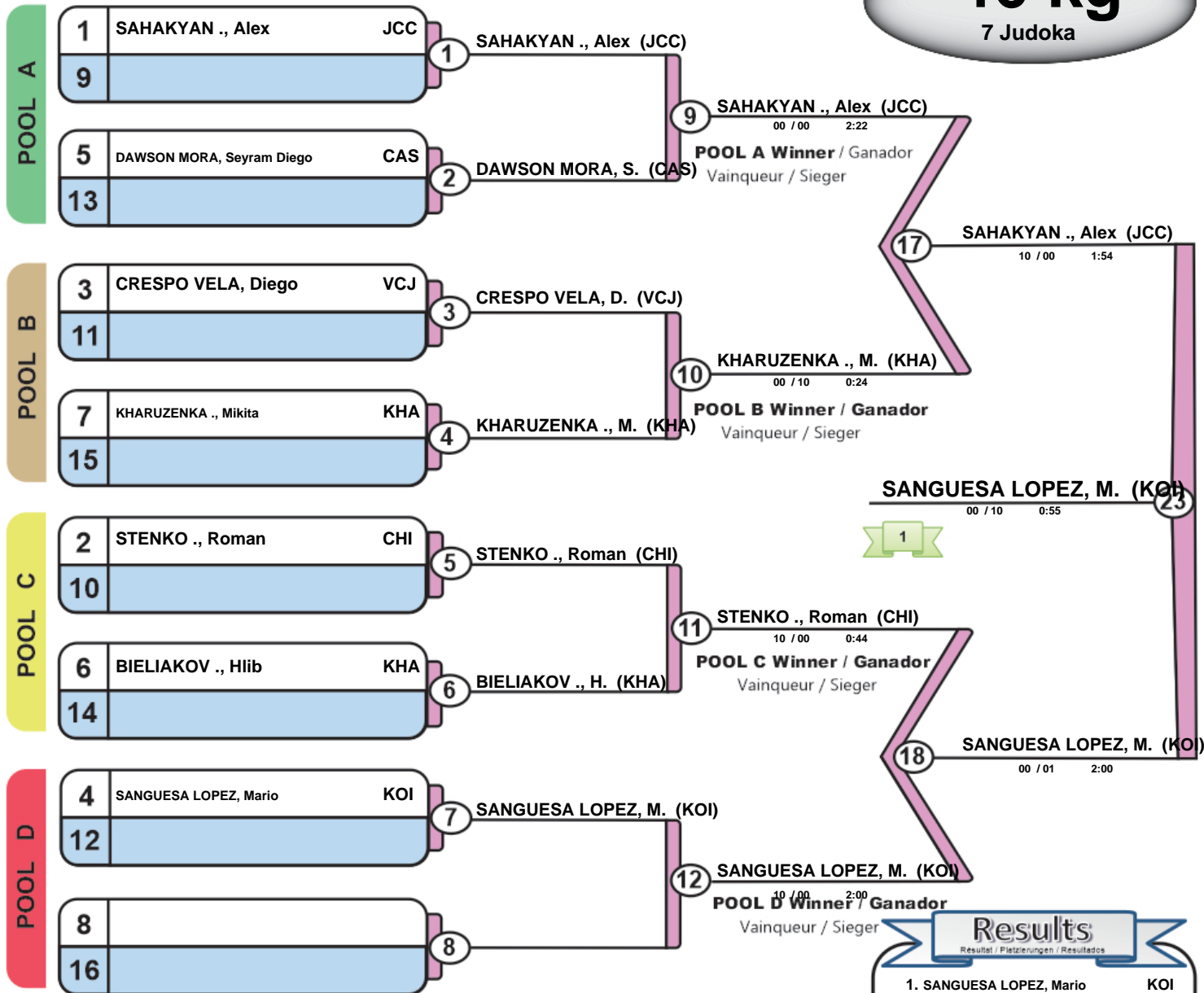

Trostrunde / Repechage / Ronda de consolación

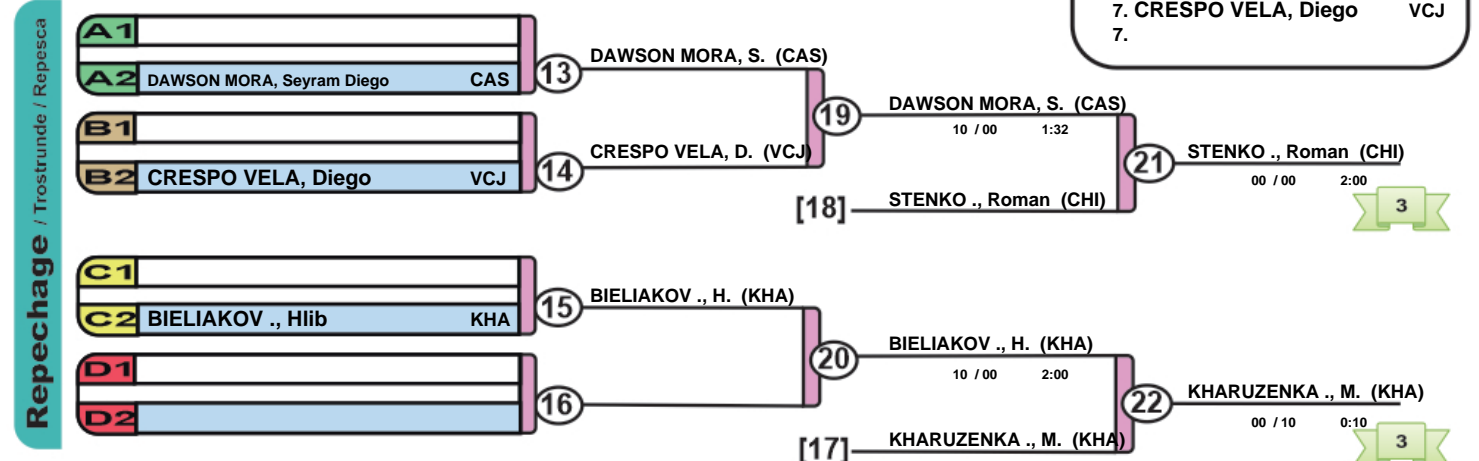

Campeonato Autonómico de Judo Alevin Valencia 2026



Polideportivo UPV (FVJ), 28 Mar 2026

-50 kg

3 Judoka

			1	2	3	Wins Score
1	GARCIA IONESCU, Izan Nicolas	KOI		0	0	0 0
2	MONTOYA HERNANDEZ, Hugo	JDR	1		1	2 0
3	AGUDO ALMAZAN, Ares	HER	1	0		1 0

1	GARCIA IONESCU, Izan Nicolas	KOI	①	MONTOYA HERNANDEZ, Hugo	JDR
2	MONTOYA HERNANDEZ, Hugo	JDR		00 / 10	1:54

1	GARCIA IONESCU, Izan Nicolas	KOI	②	AGUDO ALMAZAN, Ares	HER
3	AGUDO ALMAZAN, Ares	HER		00 / 10	0:02

2	MONTOYA HERNANDEZ, Hugo	JDR	③	MONTOYA HERNANDEZ, Hugo	JDR
3	AGUDO ALMAZAN, Ares	HER		10 / 00	0:17

Final Results

Résultat / Platzierungen / Resultados

1. MONTOYA HERNANDEZ, Hugo JDR
2. AGUDO ALMAZAN, Ares HER
- 3.



Campeonato Autonómico de Judo Alevin Valencia 2026



Polideportivo UPV (FVJ), 28 Mar 2026

-55 kg
5 Judoka

			1	3	5	Wins Score	
1	LOPEZ VAZQUEZ, Marcos	JCA		1	1	2 0	
3	HIDALGO NADAL, Hugo	EJC	0		1	1 0	
5	PASTOR COMPANY, Pau	JDK	0	0		0 0	

			2	4	Wins	Scores
2	MELIA , Hugo	GIL		1		(0)
4	ORTEGA BURGUERA, Pau	RON	0			(0)

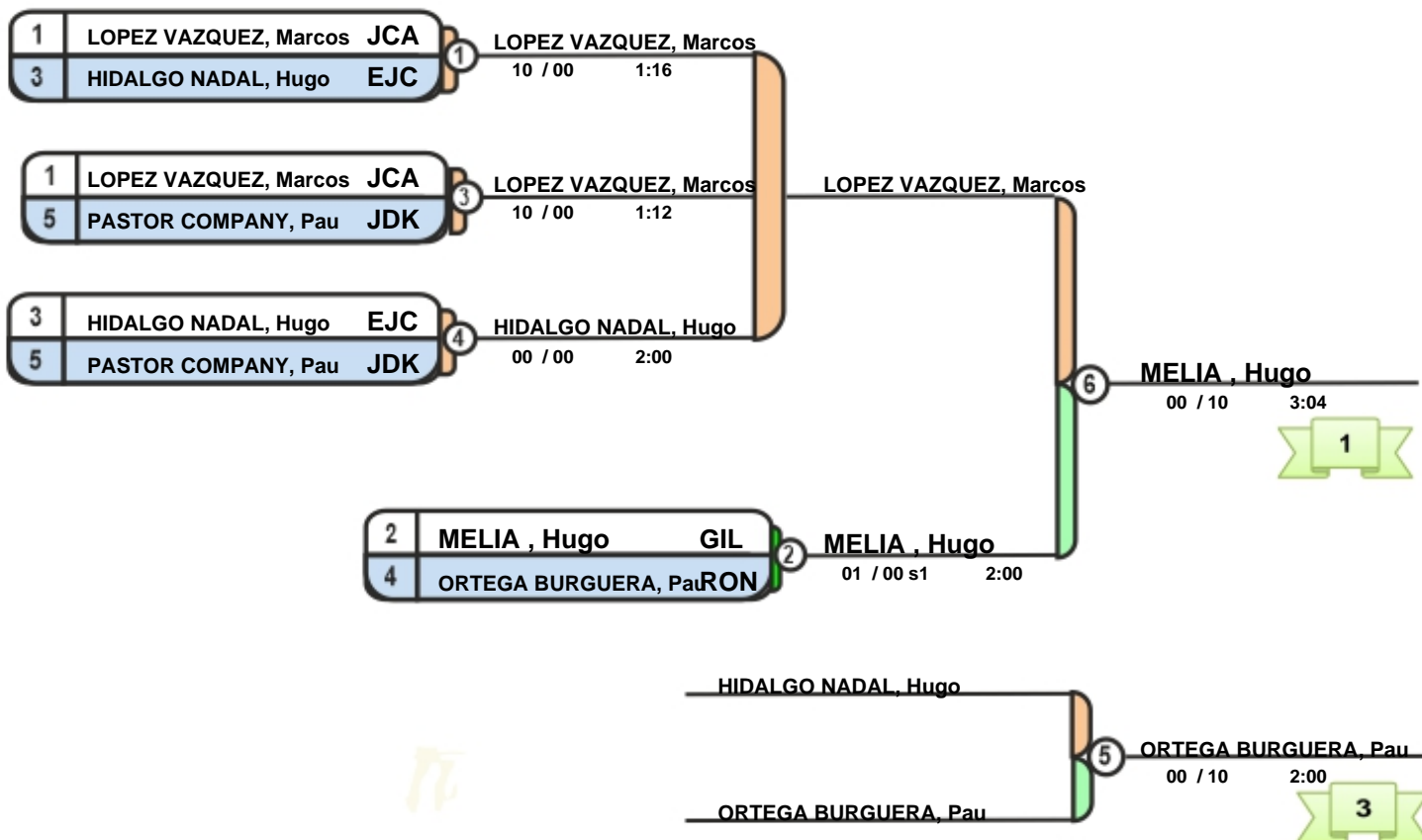

Final Results

Resultat / Platzierungen / Resultados

1. MELIA , Hugo GIL
2. LOPEZ VAZQUEZ, Marcos JCA
3. ORTEGA BURGUERA, Pau RON



Campeonato Autonómico de Judo Alevin Valencia 2026



Polideportivo UPV (FVJ), 28 Mar 2026

+55 kg

5 Judoka

			1	3	5	Wins Score	
1	GAMBOA BAVIERA, Javier	HER		1	1	2 0	
3	MANZANO MARTINEZ, Raul	JDK	0		0	0 0	
5	VAREA LORENTE, Gonzalo	REQ	0	1		1 0	

			2	4	Wins	Scores
2	DIAZ FERNANDEZ, Marc	JCA		0		(0)
4	FENOLL URENDA, Sergio	KOI	1			(0)

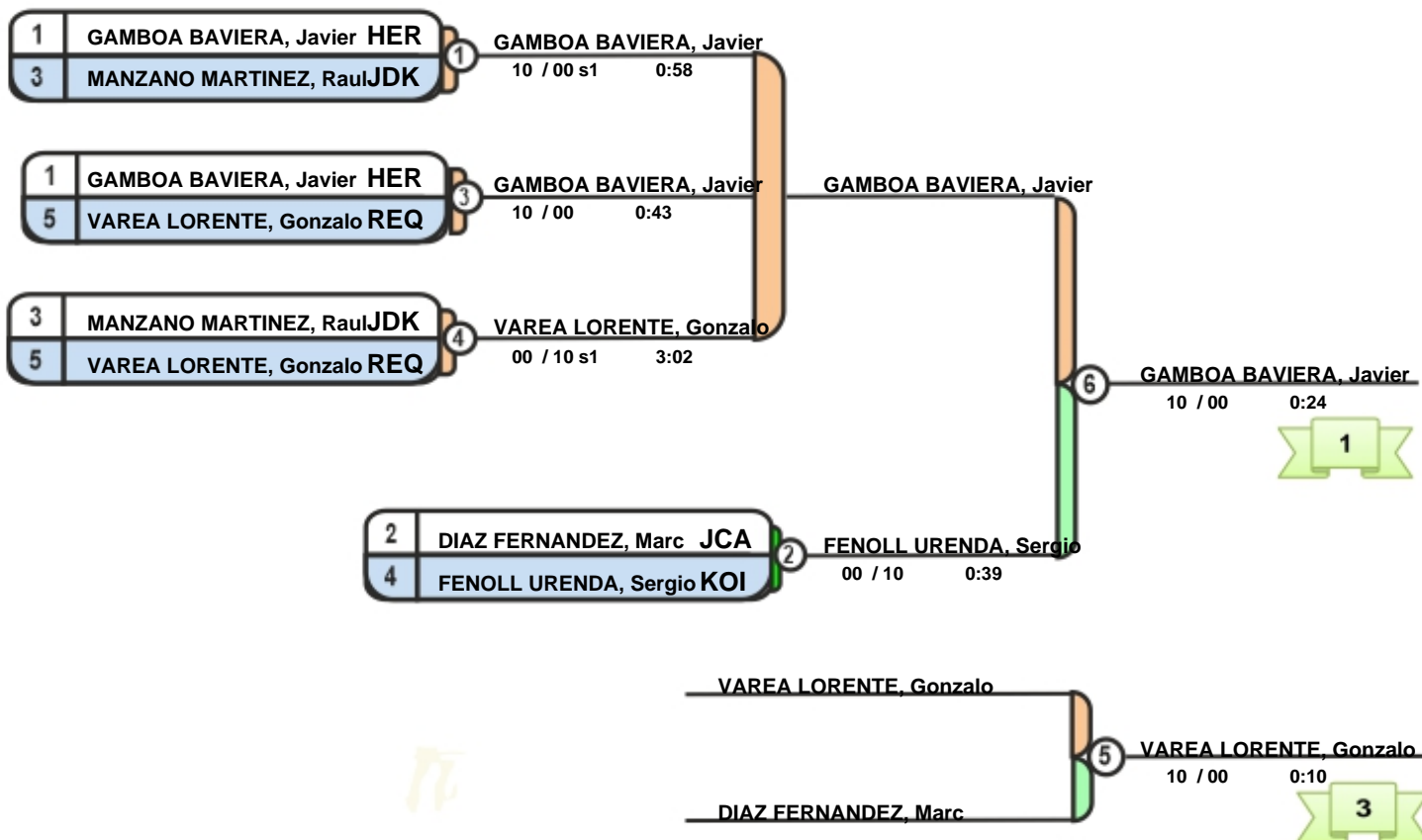

Final Results

Resultat / Platzierungen / Resultados

1. GAMBOA BAVIERA, Javier HER
2. FENOLL URENDA, Sergio KOI
3. VAREA LORENTE, Gonzalo REQ



Campeonato Autonómico de Judo Alevin Valencia 2026

Polideportivo UPV (FVJ), 28 Mar 2026

M1 -0 kg

14 Judoka

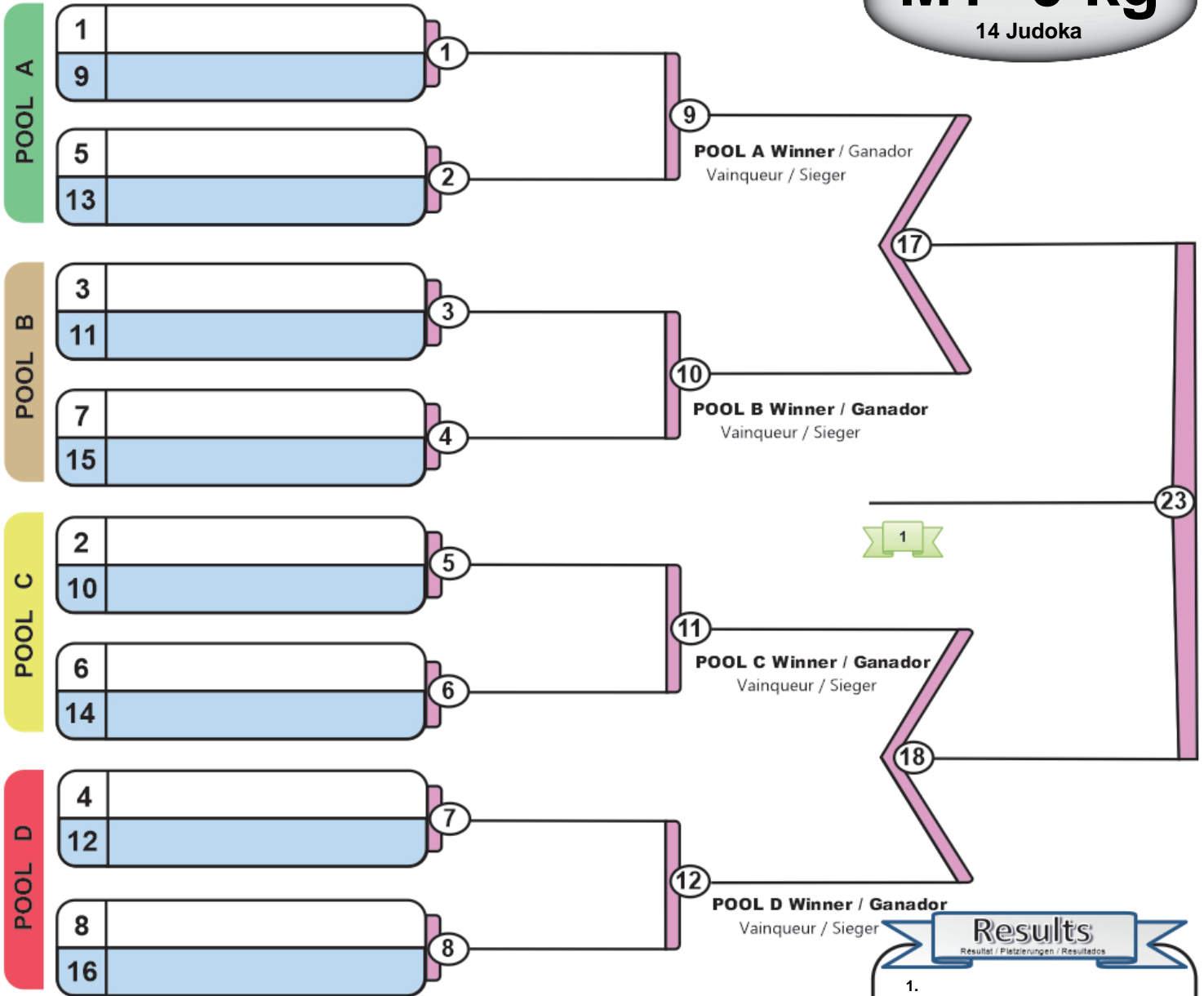

Trostrunde / Repechage / Ronda de consolación

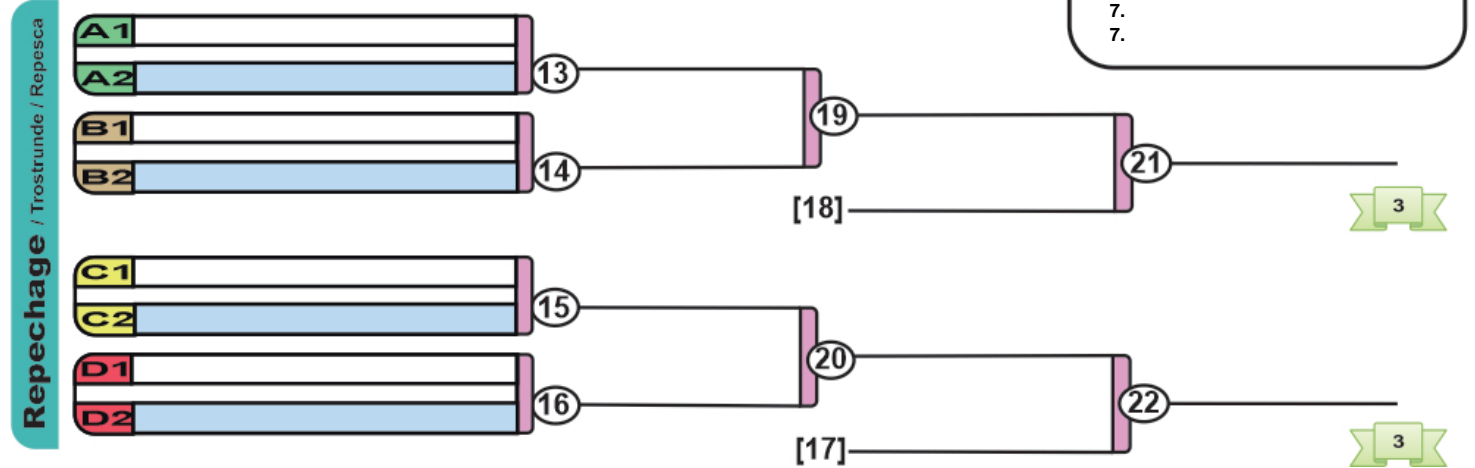

Results
Resultat / Platzierungen / Resultados

- 1.
- 2.
- 3.
- 3.
- 5.
- 7.
- 7.



			1	2	3	Wins Score
1	PARRA GREGORI, Valentina	BEN		1	1	2 0
2	ALANZABE HERNANDEZ, Noa	VCJ	0		0	0 0
3	ALONSO GUTIERREZ, Iara	JCC	0	1		1 0

1	PARRA GREGORI, Valentina	BEN	①	PARRA GREGORI, Valentina		BEN
2	ALANZABE HERNANDEZ, Noa	VCJ		10 / 00	0:06	

1	PARRA GREGORI, Valentina	BEN	②	PARRA GREGORI, Valentina		BEN
3	ALONSO GUTIERREZ, Iara	JCC		10 / 00	1:09	

2	ALANZABE HERNANDEZ, Noa	VCJ	③	ALONSO GUTIERREZ, Iara		JCC
3	ALONSO GUTIERREZ, Iara	JCC		00 / 10	0:18	

Final Results

Résultat / Platzierungen / Resultados

1. PARRA GREGORI, Valentina BEN
2. ALONSO GUTIERREZ, Iara JCC
- 3.

Campeonato Autonómico de Judo Alevin Valencia 2026

Polideportivo UPV (FVJ), 28 Mar 2026

-36 kg

10 Judoka

POOL A

1	BURGOS BALLESTER, Rosita	ELI
9	CANADA SALES, Dafne	JCC
5	HERRERO PONSODA, Noa	JDK
13		

1 BURGOS BALLESTER, R. (ELI) 01 / 00 2:00

9 BURGOS BALLESTER, R. (ELI) 10 / 00 0:26

2 HERRERO PONSODA, N. (JDK) 00 / 10 0:36

POOL A Winner / Ganador Vainqueur / Sieger

17 BURGOS BALLESTER, R. (ELI) 10 / 00 0:22

POOL B

3	SEIJO LAGO, Carmen	JCA
11		
7	DROBENKO ., Anastasiia	KHA
15		

3 SEIJO LAGO, C. (JCA) 00 / 10 1:32

4 DROBENKO ., A. (KHA) 00 / 10 0:36

POOL B Winner / Ganador Vainqueur / Sieger

23 BURGOS BALLESTER, R. (ELI) 00 / 00 2:32

POOL C

2		
10	MARINA MATEI , Sara	VCJ
6		
14	VANKERCKHOVEN FERNANDEZ, Daniella	JCC

5 MARINA MATEI , S. (VCJ) 00 / 10 1:32

6 VANKERCKHOVEN FERNANDEZ, D. (JCC) 00 / 10 1:32

POOL C Winner / Ganador Vainqueur / Sieger

18 SALES SOLA, Laia (KOI) 00 / 10 2:00

POOL D

4		
12	MILANA ., Danh	KHA
8	MEDINA CORREA, Jasmin Anahi	CAS
16	SALES SOLA, Laia	KOI

7 MILANA ., Danh (KHA) 00 / 10 0:37

8 SALES SOLA, Laia (KOI) 00 / 00 2:37

POOL D Winner / Ganador Vainqueur / Sieger

Results

- Resultat / Platzierungen / Resultados
- 1. BURGOS BALLESTER, Rosita ELI
 - 2. SALES SOLA, Laia KOI
 - 3. VANKERCKHOVEN FERNANDEZ, Daniella JCC
 - 3. MILANA ., Danh KHA
 - 5. CANADA SALES, Dafne JCC
 - 5. DROBENKO ., Anastasiia KHA
 - 7. SEIJO LAGO, Carmen JCA
 - 7. MARINA MATEI , Sara VCJ

Trostrunde / Repechage / Ronda de consolación

Repechage / Trostrunde / Repesca

A1	CANADA SALES, Dafne	JCC
A2	HERRERO PONSODA, Noa	JDK
B1		
B2	SEIJO LAGO, Carmen	JCA

13 CANADA SALES, D. (JCC) 00 s2 / 00 0:20

14 SEIJO LAGO, C. (JCA) 10 / 00 1:55

19 CANADA SALES, D. (JCC) 00 / 10 0:33

21 VANKERCKHOVEN FERNANDEZ, D. (JCC) 00 / 10 0:33

C1		
C2	MARINA MATEI , Sara	VCJ
D1	MEDINA CORREA, Jasmin Anahi	CAS
D2	MILANA ., Danh	KHA

15 MARINA MATEI , S. (VCJ) 00 / 10 1:54

16 MILANA ., Danh (KHA) 00 / 00 1:36

20 MILANA ., Danh (KHA) 10 / 00 0:40

22 MILANA ., Danh (KHA) 10 / 00 0:40

17 DROBENKO ., A. (KHA)



Campeonato Autonómico de Judo Alevin Valencia 2026

Polideportivo UPV (FVJ), 28 Mar 2026

-40 kg

7 Judoka

POOL A

1 MARTINEZ FERRIZ, Isabel JSC
9

1 MARTINEZ FERRIZ, I. (JSC)

5 GARRIDO CORTES, Paula JKA
13

2 GARRIDO CORTES, P. (JKA)

9 GARRIDO CORTES, P. (JKA)
00 / 01 s1 2:00
POOL A Winner / Ganador
Vainqueur / Sieger

POOL B

3 GASCON DEL TORO, Triana OBI
11

3 GASCON DEL TORO, T. (OBI)

7 MONTESINOS MARCO, Daniela JCC
15

4 MONTESINOS MARCO, D. (JCC)

10 MONTESINOS MARCO, D. (JCC)
00 / 10 0:29
POOL B Winner / Ganador
Vainqueur / Sieger

POOL C

2 DASCALESCU ., Ariana Veronica JCC
10

5 DASCALESCU ., A. (JCC)

6 ZORRILLA PASTOR, Valentina GIL
14

6 ZORRILLA PASTOR, V. (GIL)

11 ZORRILLA PASTOR, V. (GIL)
00 / 00 2:00
POOL C Winner / Ganador
Vainqueur / Sieger

POOL D

4
12

7

8 GARCIA FERNANDEZ, Miranda KOI
16

8 GARCIA FERNANDEZ, M. (KOI)

12 GARCIA FERNANDEZ, M. (KOI)
00 / 10 2:00
POOL D Winner / Ganador
Vainqueur / Sieger

17 MONTESINOS MARCO, D. (JCC)
00 / 00 2:00

23 GARCIA FERNANDEZ, M. (KOI)
00 / 00 2:00



18 GARCIA FERNANDEZ, M. (KOI)
00 / 10 0:36

Results

Resultat / Platzierungen / Resultados

- GARCIA FERNANDEZ, Miranda KOI
- MONTESINOS MARCO, Daniela JCC
- ZORRILLA PASTOR, Valentina GIL
- GARRIDO CORTES, Paula JKA
- DASCALESCU ., Ariana Veronica JCC
- GASCON DEL TORO, Triana OBI
- 7.

Trostrunde / Repechage / Ronda de consolación

Repechage / Trostrunde / Repesca

A1
A2 MARTINEZ FERRIZ, Isabel JSC

13 MARTINEZ FERRIZ, I. (JSC)

B1
B2 GASCON DEL TORO, Triana OBI

14 GASCON DEL TORO, T. (OBI)

19 MARTINEZ FERRIZ, I. (JSC)
10 / 00 0:44

[18] ZORRILLA PASTOR, V. (GIL)

21 ZORRILLA PASTOR, V. (GIL)
00 / 10 0:16



C1
C2 DASCALESCU ., Ariana Veronica JCC

15 DASCALESCU ., A. (JCC)

D1
D2

16

20 DASCALESCU ., A. (JCC)
10 / 00 2:00

[17] GARRIDO CORTES, P. (JKA)

22 GARRIDO CORTES, P. (JKA)
00 / 11 2:00



Campeonato Autonómico de Judo Alevin Valencia 2026

Polideportivo UPV (FVJ), 28 Mar 2026

-44 kg

15 Judoka

POOL A

1	FERREIRA SANTOS, Nathalia Del Carmen	OBI
9	MARTINEZ RIVAS, Sara	JKA
5	CABANES GUILLIN, Daniela	JKA
13	LOPEZ DE LA FUENTE, Aitana	JCC

1 MARTINEZ RIVAS, S. (JKA)
00 / 10 0:39

9 LOPEZ DE LA FUENTE, A. (JCC)
00 / 10 1:11

2 LOPEZ DE LA FUENTE, A. (JCC)
00 / 10 0:11

POOL A Winner / Ganador
Vainqueur / Sieger

17 LOPEZ DE LA FUENTE, A. (JCC)
11 / 00 1:48

POOL B

3	MILIEVYCH ., Olena	VCJ
11	GARCIA BLAYA, Elena	JDK
7	COSTA SANCHO, Mireia	ELI
15	ORTEGA SAMPABLO, Berta	JKA

3 GARCIA BLAYA, E. (JDK)
00 / 10 0:15

10 COSTA SANCHO, M. (ELI)
00 / 00 2:00

4 COSTA SANCHO, M. (ELI)
10 / 00 1:03

POOL B Winner / Ganador
Vainqueur / Sieger

23 JOYA SEGURA, E. (KOI)
00 / 01 2:00

POOL C

2	LLACER GIL, Carlie	JRV
10	MENDOZA GARCIA, Maria	VCJ
6		
14	CARBONELL AVILA, Ariadna	JKA

5 LLACER GIL, C. (JRV)
10 / 00 1:05

11 CARBONELL AVILA, A. (JKA)
00 / 10 0:10

6 CARBONELL AVILA, A. (JKA)
00 / 10 0:10

POOL C Winner / Ganador
Vainqueur / Sieger

18 JOYA SEGURA, E. (KOI)
00 / 10 0:53

POOL D

4	JOYA SEGURA, Elisa	KOI
12	MARTINEZ PIA, Clara	JKA
8	LOPEZ ANTUNEZ, Livia	JKA
16	CREVILLEN BALLESTER, Rebeca	JDK

7 JOYA SEGURA, E. (KOI)
10 / 00 0:17

12 JOYA SEGURA, E. (KOI)
10 / 00 0:20

8 CREVILLEN BALLESTER, R. (JDK)
00 / 10 0:06

POOL D Winner / Ganador
Vainqueur / Sieger

Results

- Resultat / Platzierungen / Resultados
- 1. JOYA SEGURA, Elisa KOI
 - 2. LOPEZ DE LA FUENTE, Aitana JCC
 - 3. GARCIA BLAYA, Elena JDK
 - 3. CREVILLEN BALLESTER, Rebeca JDK
 - 5. CARBONELL AVILA, Ariadna JKA
 - 5. COSTA SANCHO, Mireia ELI
 - 7. MARTINEZ RIVAS, Sara JKA
 - 7. LLACER GIL, Carlie JRV

Trostrunde / Repechage / Ronda de consolación

Repechage / Trostrunde / Repecha

A1	CABANES GUILLIN, Daniela	JKA
A2	MARTINEZ RIVAS, Sara	JKA

13 MARTINEZ RIVAS, S. (JKA)
00 / 00 1:45

19 GARCIA BLAYA, E. (JDK)
00 / 10 0:11

B1	ORTEGA SAMPABLO, Berta	JKA
B2	GARCIA BLAYA, Elena	JDK

14 GARCIA BLAYA, E. (JDK)
00 / 10 1:52

21 GARCIA BLAYA, E. (JDK)
10 / 00 1:09

18 CARBONELL AVILA, A. (JKA)

C1		
C2	LLACER GIL, Carlie	JRV

15 LLACER GIL, C. (JRV)

20 CREVILLEN BALLESTER, R. (JDK)
00 / 00 0:11

D1	MARTINEZ PIA, Clara	JKA
D2	CREVILLEN BALLESTER, Rebeca	JDK

16 CREVILLEN BALLESTER, R. (JDK)
00 / 10 1:53

22 CREVILLEN BALLESTER, R. (JDK)
10 / 00 0:22

17 COSTA SANCHO, M. (ELI)

Campeonato Autonómico de Judo Alevin Valencia 2026

Polideportivo UPV (FVJ), 28 Mar 2026

-48 kg

6 Judoka

POOL A

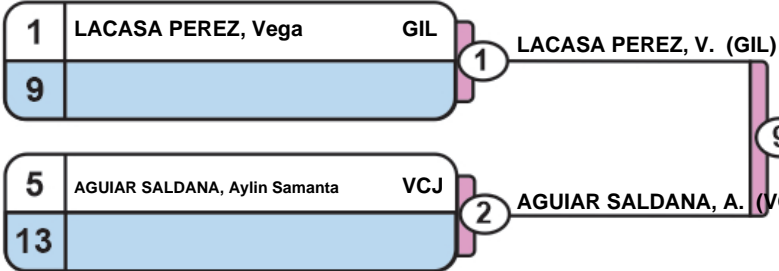

9 LACASA PEREZ, V. (GIL)
01 / 00 2:00
POOL A Winner / Ganador
Vainqueur / Sieger

POOL B

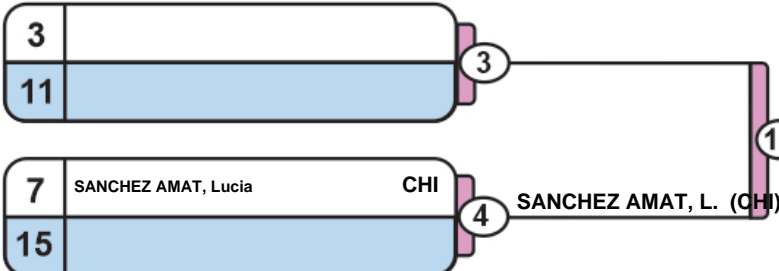

10 SANCHEZ AMAT, L. (CHI)
00 / 10 2:00
POOL B Winner / Ganador
Vainqueur / Sieger

POOL C

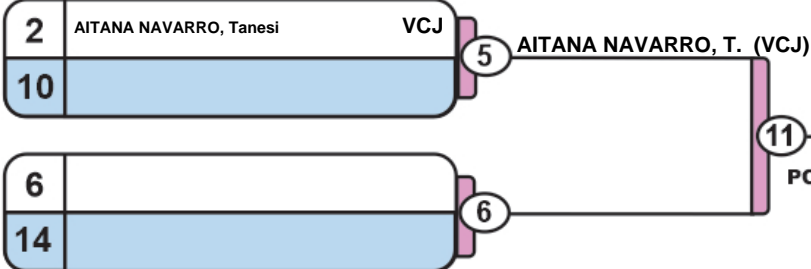

11 AITANA NAVARRO, T. (VCJ)
10 / 00 2:00
POOL C Winner / Ganador
Vainqueur / Sieger

POOL D

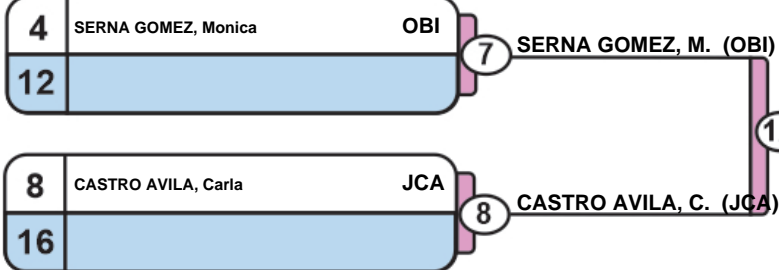

12 CASTRO AVILA, C. (JCA)
00 / 10 0:16
POOL D Winner / Ganador
Vainqueur / Sieger

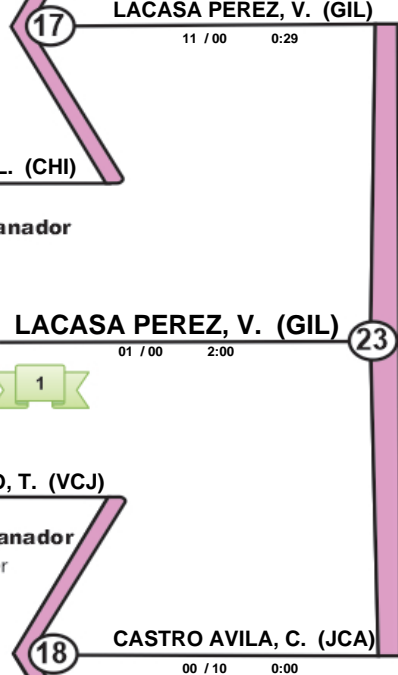

23 LACASA PEREZ, V. (GIL)
01 / 00 2:00



Results

Resultat / Platzierungen / Resultados

1. LACASA PEREZ, Vega	GIL
2. CASTRO AVILA, Carla	JCA
3. AGUIAR SALDANA, Aylin Samanta	VCJ
3. SERNA GOMEZ, Monica	OBI
5. AITANA NAVARRO, Tanesi	VCJ
5. SANCHEZ AMAT, Lucia	CHI
7.	
7.	

Trostrunde / Repechage / Ronda de consolación

Repechage / Trostrunde / Repesca

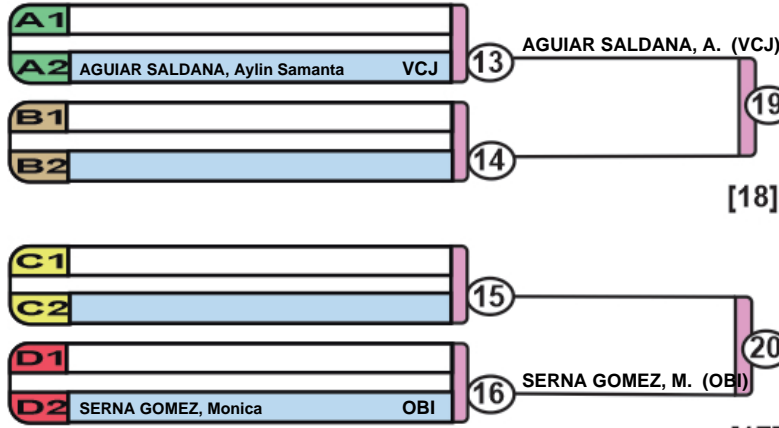

19 AGUIAR SALDANA, A. (VCJ)
10 / 00 2:00

20 SERNA GOMEZ, M. (OBI)
00 / 10 2:00

21 AGUIAR SALDANA, A. (VCJ)
10 / 00 1:54

22 SERNA GOMEZ, M. (OBI)
10 / 00 0:34

Campeonato Autonómico de Judo Alevin Valencia 2026

Polideportivo UPV (FVJ), 28 Mar 2026

-52 kg

10 Judoka

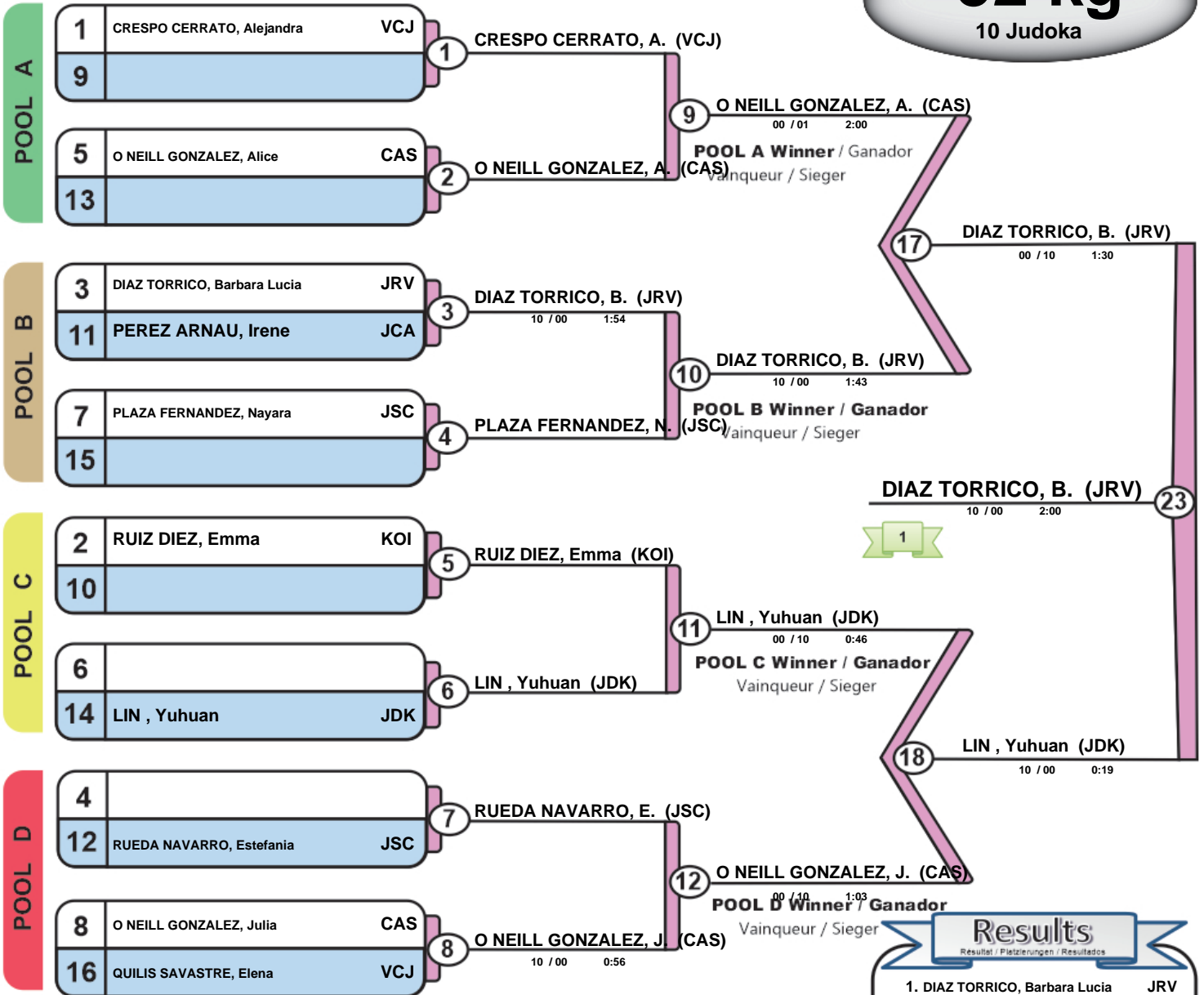

Results		
Resultat / Platzierungen / Resultados		
1.	DIAZ TORRICO, Barbara Lucia	JRV
2.	LIN, Yuhuan	JDK
3.	O NEILL GONZALEZ, Julia	CAS
3.	O NEILL GONZALEZ, Alice	CAS
5.	PLAZA FERNANDEZ, Nayara	JSC
5.	QUILIS SAVASTRE, Elena	VCJ
7.	CRESPO CERRATO, Alejandra	VCJ
7.	RUIZ DIEZ, Emma	KOI

Trostrunde / Repechage / Ronda de consolación

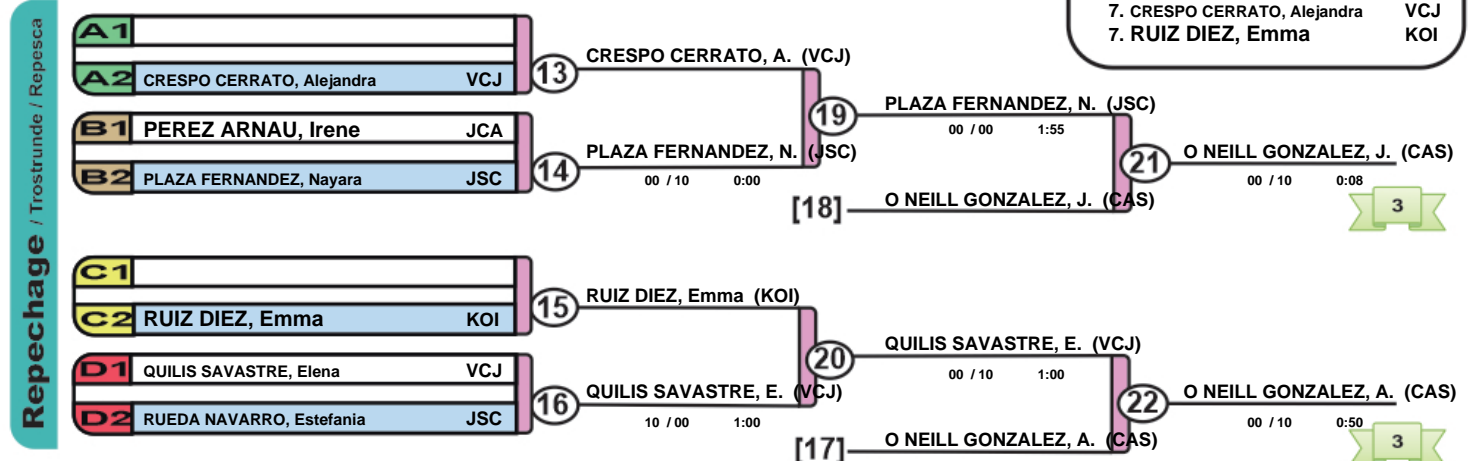

Campeonato Autonómico de Judo Alevin Valencia 2026

Polideportivo UPV (FVJ), 28 Mar 2026

+52 kg

6 Judoka

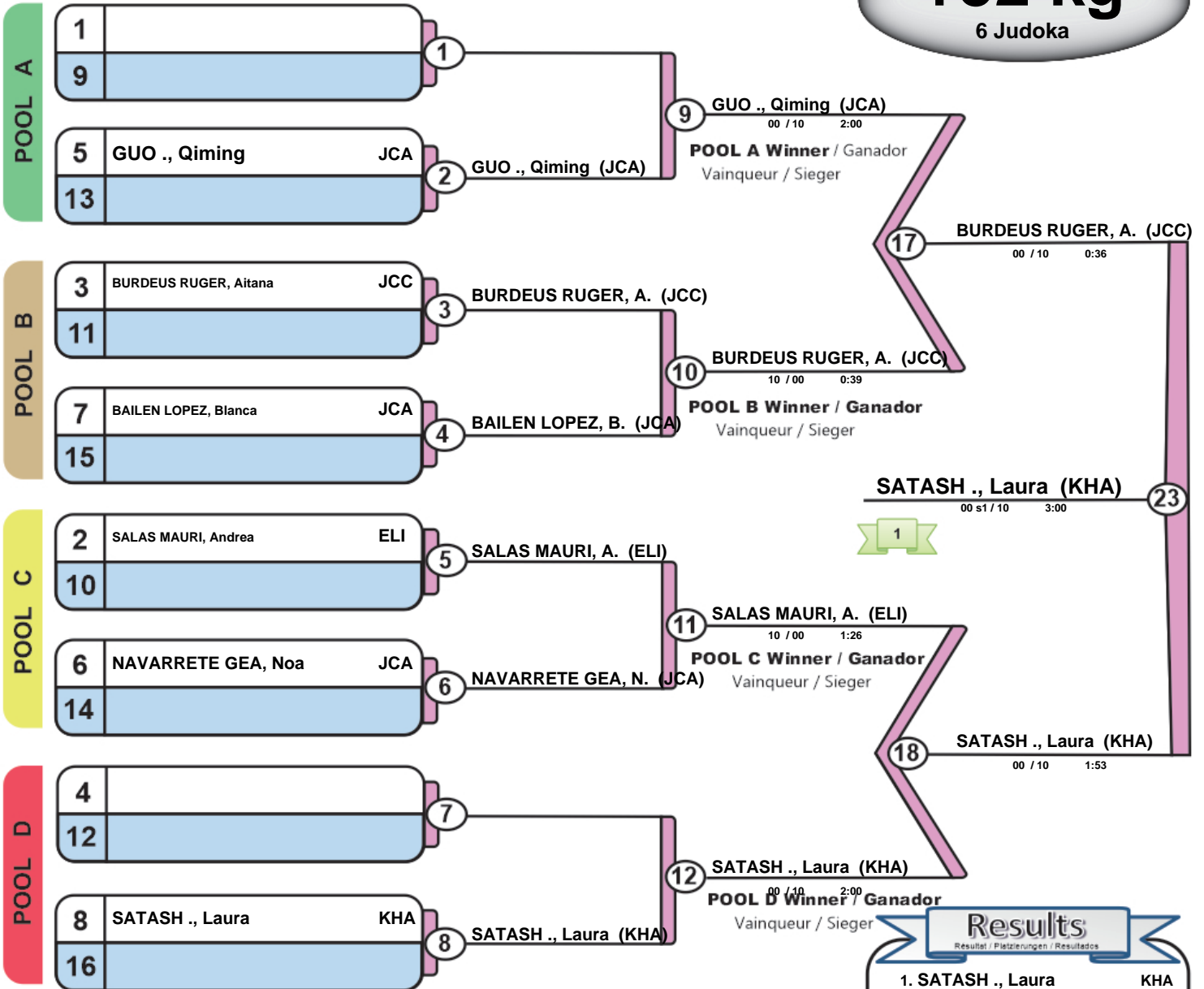

Results

Resultat / Platzierungen / Resultados

1. SATASH., Laura	KHA
2. BURDEUS RUGER, Aitana	JCC
3. SALAS MAURI, Andrea	ELI
3. NAVARRETE GEA, Noa	JCA
5. BAILEN LOPEZ, Blanca	JCA
5. GUO., Qiming	JCA
7.	
7.	

Trostrunde / Repechage / Ronda de consolación

