

XXXVII Jocs Esportius CV 10/11/18 Valencia Inf F -36

Competidores

Competidores: 2

Nº	Nombre	Club	1	2	Victs.	Pts.	Pos.
1	LAIA FERRANDIS ARNAU	JC CANET		10	1	10	1
2	ROCIO GARCIA DE PRADOS	OLIMPIC PUZOL			0	0	2

Combates

Comb.	Blanco		Azul	Resultado	Tiempo	
1	LAIA FERRANDIS ARNAU	1	2	ROCIO GARCIA DE PRADOS	10-0	0:00

Clasificación

Pos.	Nombre
1	LAIA FERRANDIS ARNAU, JC CANET
2	ROCIO GARCIA DE PRADOS, OLIMPIC PUZOL

XXXVII Jocs Esportius CV 10/11/18 Valencia Inf F -40

Competidores

Competidores: 2

Nº	Nombre	Club	1	2	Victs.	Pts.	Pos.
1	MARTA PASTOR CALVO	JC CASTALLA		10	1	10	1
2	LUCIA LOPEZ ARGENTE	JC ALZIRA			0	0	2

Combates

Comb.	Blanco		Azul	Resultado	Tiempo
1	MARTA PASTOR CALVO	1	2 LUCIA LOPEZ ARGENTE	10-0	0:00

Clasificación

Pos.	Nombre
1	MARTA PASTOR CALVO, JC CASTALLA
2	LUCIA LOPEZ ARGENTE, JC ALZIRA

XXXVII Jocs Esportius CV 10/11/18 Valencia Inf F -44

Competidores: 7

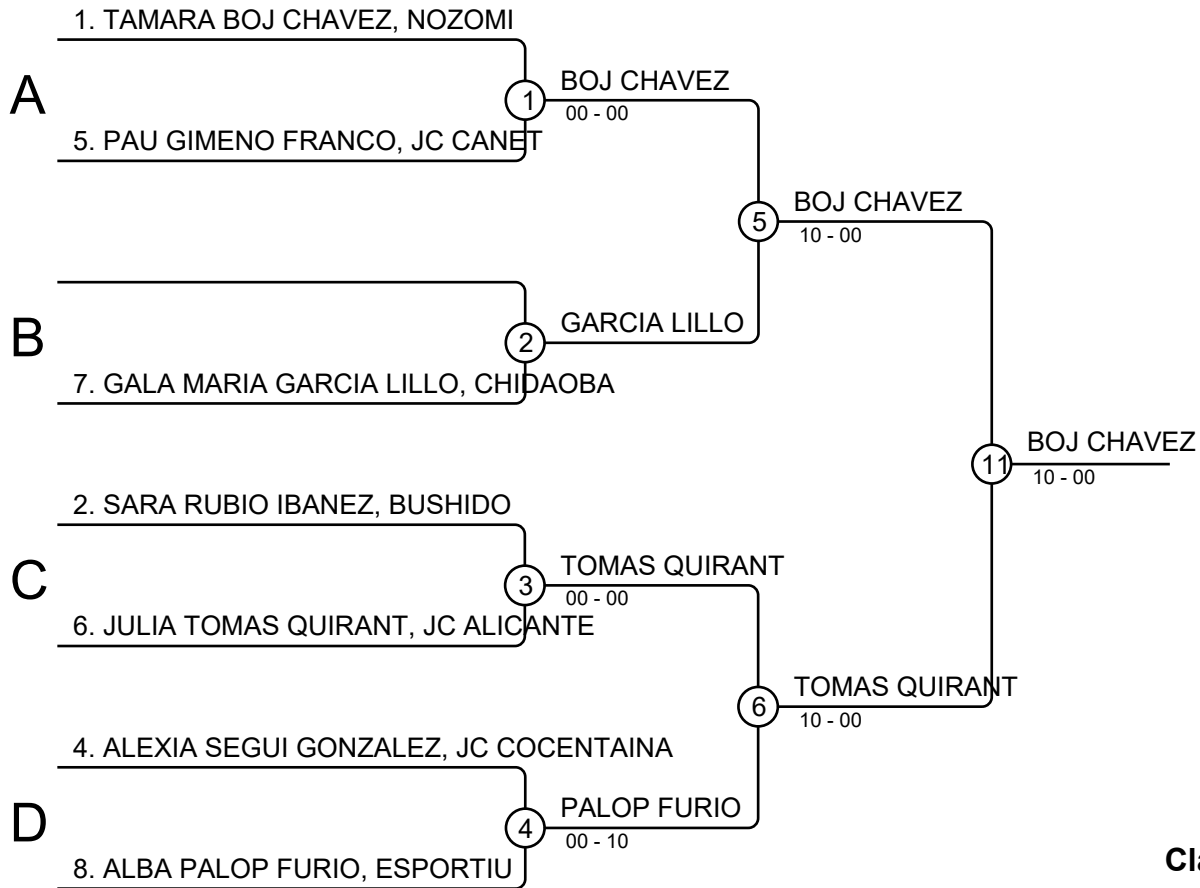

Clasificación

Pos.	Nombre
1	TAMARA BOJ CHAVEZ, NOZOMI
2	JULIA TOMAS QUIRANT, JC ALICANTE
3	PAU GIMENO FRANCO, JC CANET
3	GALA MARIA GARCIA LILLO, CHIDAOPA
5	ALBA PALOP FURIO, ESPORTIU
5	SARA RUBIO IBANEZ, BUSHIDO
7	
7	ALEXIA SEGUI GONZALEZ, JC COCENTAINA

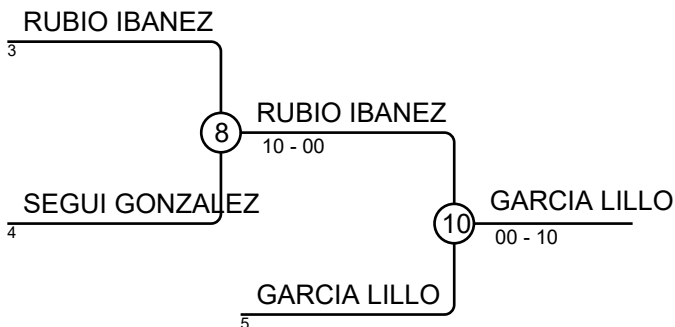
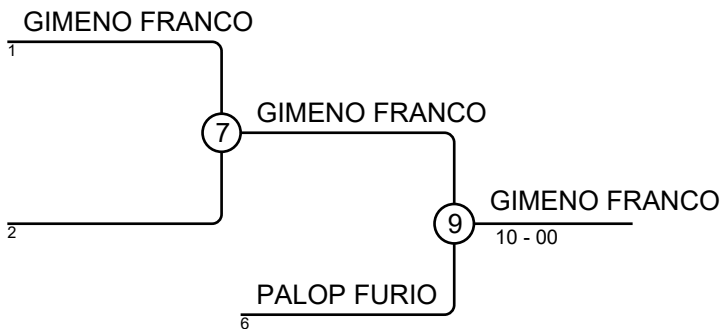

XXXVII Jocs Esportius CV 10/11/18 Valencia Inf F -48

Competidores: 9

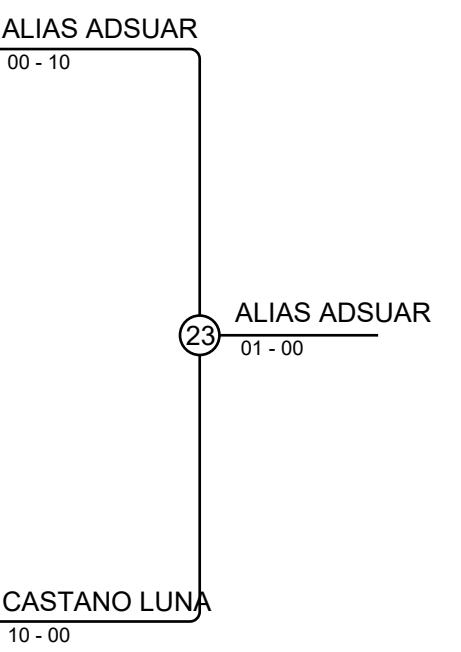
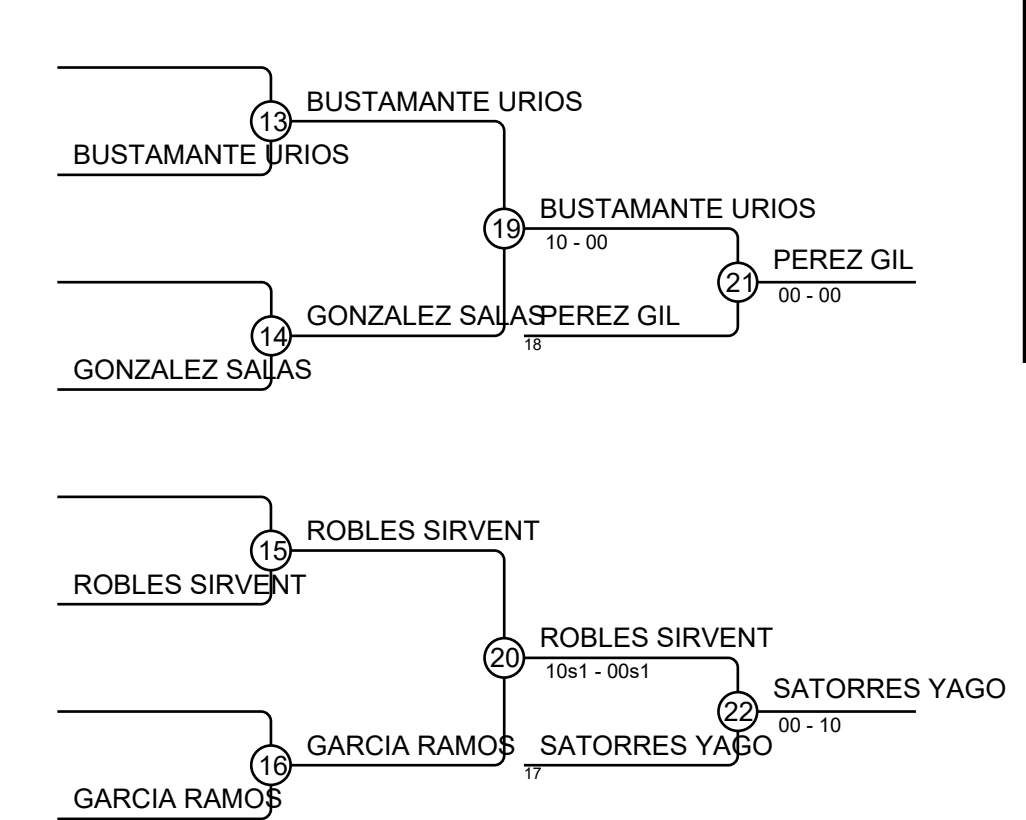
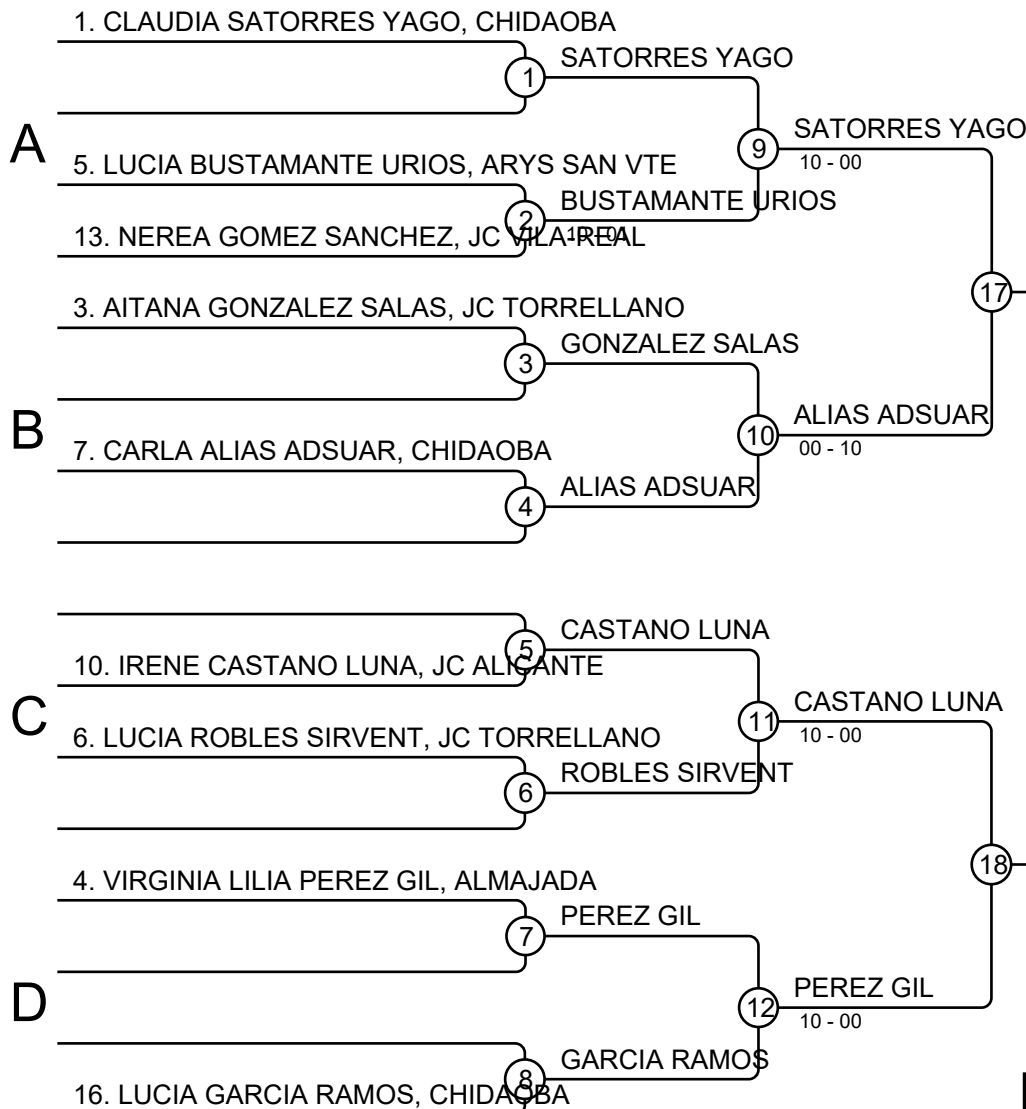

Clasificación

Pos.	Nombre
1	CARLA ALIAS ADSUAR, CHIDA OBA
2	IRENE CASTANO LUNA, JC ALICANTE
3	VIRGINIA LILIA PEREZ GIL, ALMAJADA
3	CLAUDIA SATORRES YAGO, CHIDA OBA
5	LUCIA BUSTAMANTE URIOS, ARYS SAN VTE
5	LUCIA ROBLES SIRVENT, JC TORRELLANO
7	AITANA GONZALEZ SALAS, JC TORRELLANO
7	LUCIA GARCIA RAMOS, CHIDA OBA

XXXVII Jocs Esportius CV 10/11/18 Valencia Inf F -52

Competidores: 8

1. VIRGINIA GARCIA MOYA, JC ALICANTE

A



B

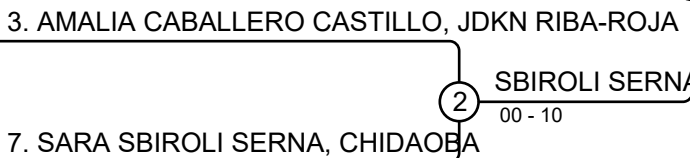

C

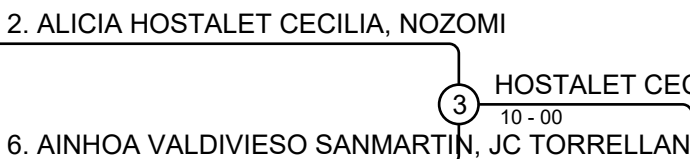

D

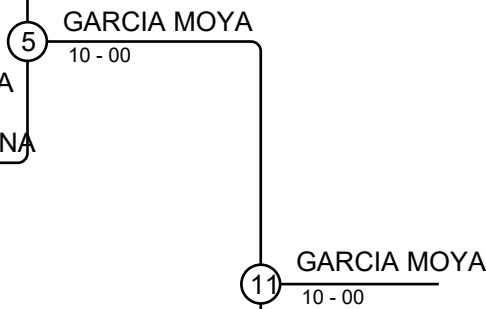
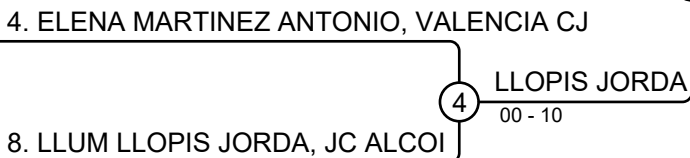

Clasificación

Pos.	Nombre
1	VIRGINIA GARCIA MOYA, JC ALICANTE
2	LLUM LLOPIS JORDA, JC ALCOI
3	AMALIA CABALLERO CASTILLO, JDKN RIBA-ROJA
3	SARA SBIROLI SERNA, CHIDA OBA
5	ALICIA HOSTALET CECILIA, NOZOMI
5	ELENA MARTINEZ ANTONIO, VALENCIA CJ
7	Mª AMPARO JIMENEZ MERLO, HERCA
7	AINHOA VALDIVIESO SANMARTIN, JC TORRELLANO

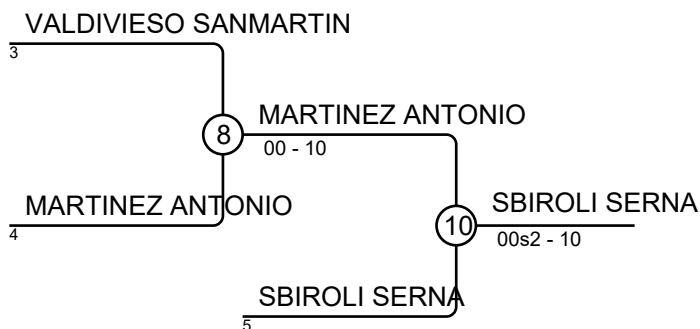
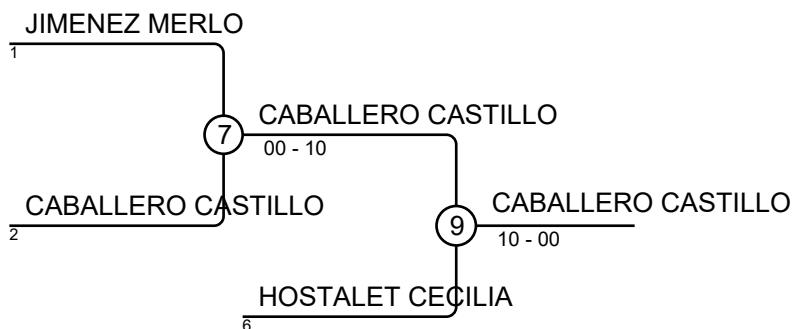

XXXVII Jocs Esportius CV 10/11/18 Valencia Inf F -57

Competidores

Competidores: 3

Nº	Nombre	Club	1	2	3	Victs.	Pts.	Pos.
1	LOURDES RAMIREZ VALERO	JC ALMORADI				0	0	3
2	MIREIA GUAL MONFORT	BUDOKAN	10			1	10	2
3	INES OROZ MIQUEL	JDKN RIBA-ROJA	10	10		2	20	1

Combates

Comb.	Blanco			Azul	Resultado	Tiempo
1	LOURDES RAMIREZ VALERO	1	2	MIREIA GUAL MONFORT	0-10	0:00
2	LOURDES RAMIREZ VALERO	1	3	INES OROZ MIQUEL	0-10	0:00
3	MIREIA GUAL MONFORT	2	3	INES OROZ MIQUEL	0-10	0:00

Clasificación

Pos.	Nombre
1	INES OROZ MIQUEL, JDKN RIBA-ROJA
2	MIREIA GUAL MONFORT, BUDOKAN
3	LOURDES RAMIREZ VALERO, JC ALMORADI

XXXVII Jocs Esportius CV 10/11/18 Valencia Inf F -63

Competidores: 6

1. MIREIA GARCIA LOPEZ, JC ALICANTE

A



3. AITANA PERIGUELL GARCIA, BUSHIDO

B



C

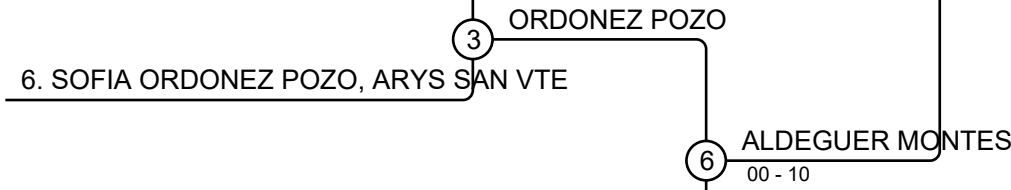

4. TANIA PARDO ORTEGA, JDKN RIBA-ROJA

D

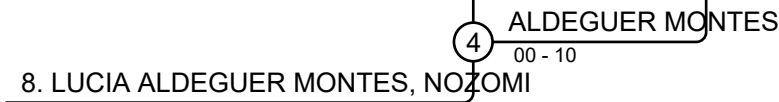

11 ALDEGUER MONTES

00 - 10s1

Clasificación

Pos.	Nombre
1	LUCIA ALDEGUER MONTES, NOZOMI
2	AITANA PERIGUELL GARCIA, BUSHIDO
3	LUCIA ESTEBAN HURTADO, JC TORREVIEJA
3	MIREIA GARCIA LOPEZ, JC ALICANTE
5	SOFIA ORDONEZ POZO, ARYS SAN VTE
5	TANIA PARDO ORTEGA, JDKN RIBA-ROJA
7	
7	

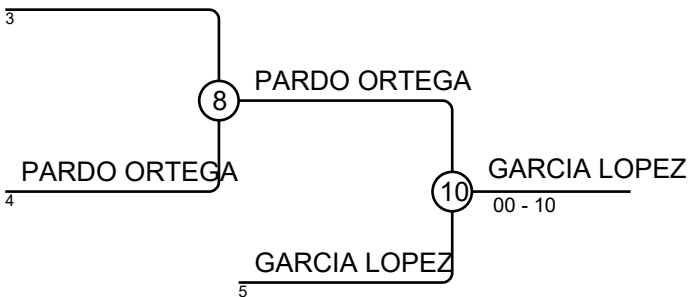
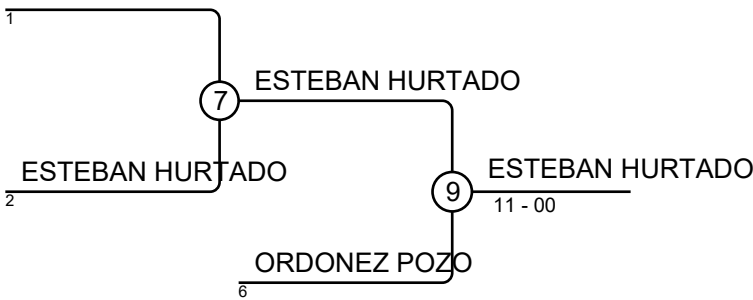

XXXVII Jocs Esportius CV 10/11/18 Valencia Inf F +63

Competidores

Competidores: 3

Nº	Nombre	Club	1	2	3	Victs.	Pts.	Pos.
1	CLAUDIA LOPEZ VALVERDE	CD ALGAR				0	0	3
2	RAISSA PLASENCIA MORA	JC ALMORADI	10			1	10	2
3	AITANA SALA CANO	VALENCIA CJ	10	10		2	20	1

Combates

Comb.	Blanco			Azul	Resultado	Tiempo
1	CLAUDIA LOPEZ VALVERDE	1	2	RAISSA PLASENCIA MORA	0-10	0:00
2	CLAUDIA LOPEZ VALVERDE	1	3	AITANA SALA CANO	0-10	0:00
3	RAISSA PLASENCIA MORA	2	3	AITANA SALA CANO	0-10	0:00

Clasificación

Pos.	Nombre
1	AITANA SALA CANO, VALENCIA CJ
2	RAISSA PLASENCIA MORA, JC ALMORADI
3	CLAUDIA LOPEZ VALVERDE, CD ALGAR

XXXVII Jocs Esportius CV 10/11/18 Valencia Inf M -38

Competidores: 11

1. PEDRO LORENTE PALANCA, JC ALZIRA

A



B

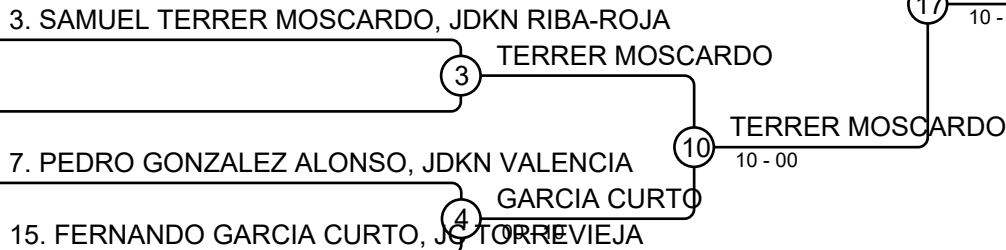

C

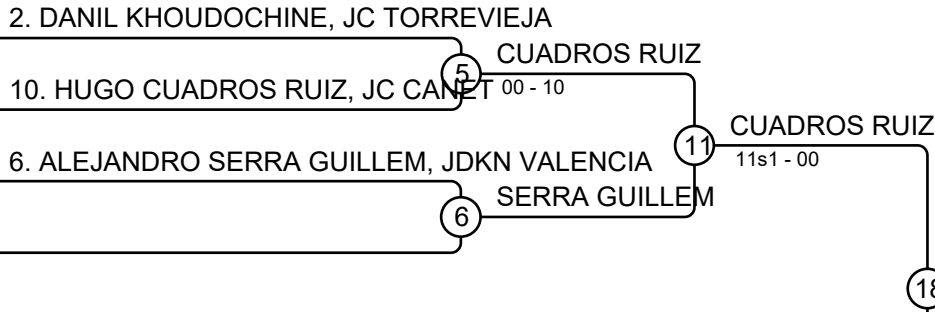

D

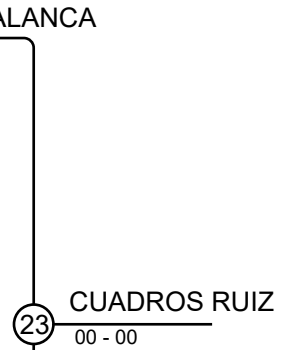
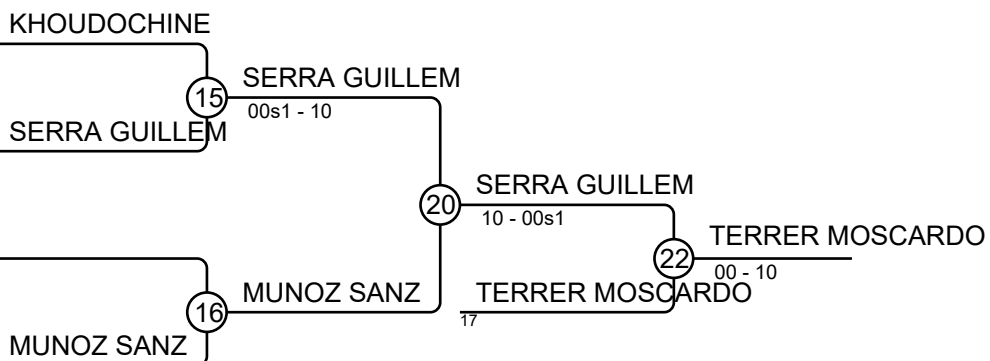
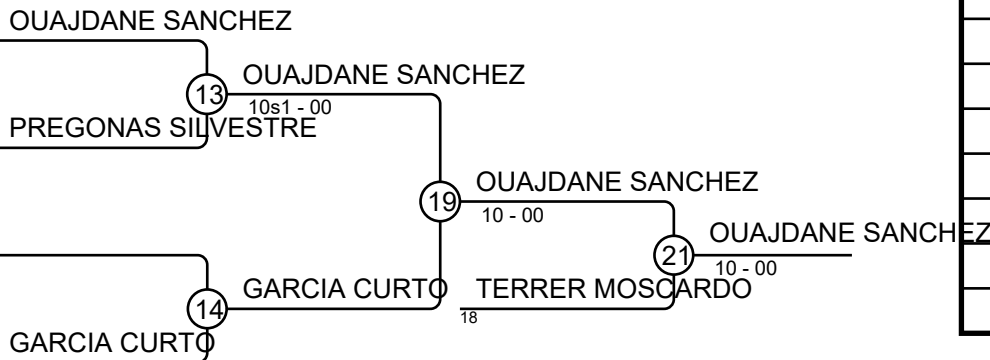
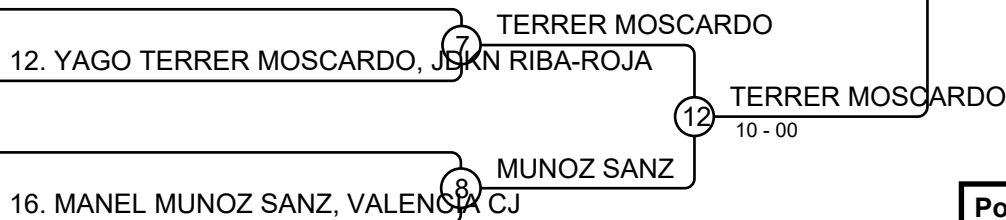

Clasificación

Pos.	Nombre
1	HUGO CUADROS RUIZ, JC CANET
2	PEDRO LORENTE PALANCA, JC ALZIRA
3	ISAAC OUAJDANE SANCHEZ, JDKN VALENCIA
3	SAMUEL TERRER MOSCARDO, JDKN RIBA-ROJA
5	YAGO TERRER MOSCARDO, JDKN RIBA-ROJA
5	ALEJANDRO SERRA GUILLEM, JDKN VALENCIA
7	FERNANDO GARCIA CURTO, JC TORREVIEJA
7	MANEL MUNOZ SANZ, VALENCIA CJ

XXXVII Jocs Esportius CV 10/11/18 Valencia Inf M -42

Competidores: 13

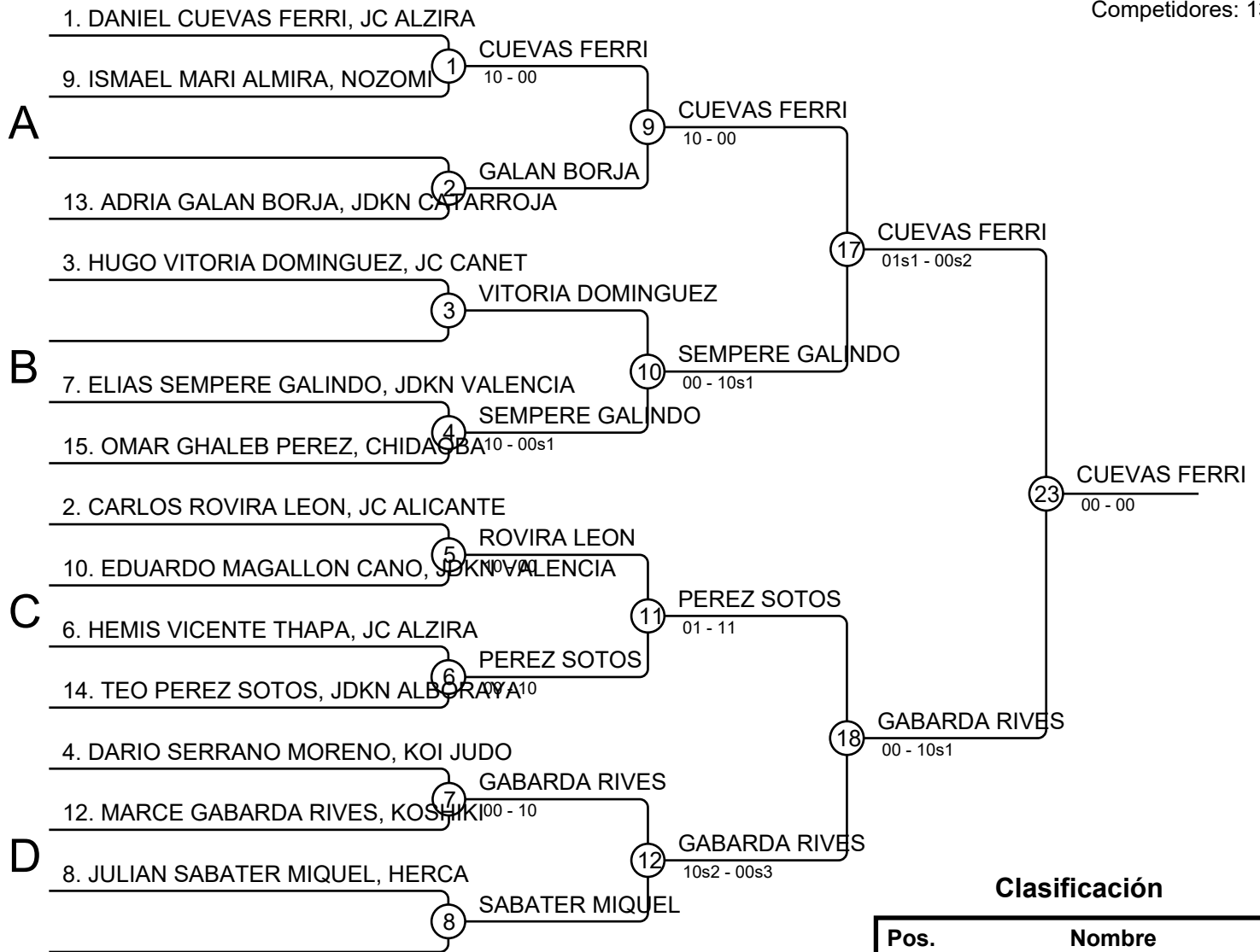

Clasificación

Pos.	Nombre
1	DANIEL CUEVAS FERRI, JC ALZIRA
2	MARCE GABARDA RIVES, KOSHIKI
3	ISMAEL MARI ALMIRA, NOZOMI
3	ELIAS SEMPERE GALINDO, JDKN VALENCIA
5	TEO PEREZ SOTOS, JDKN ALBORAYA
5	CARLOS ROVIRA LEON, JC ALICANTE
7	OMAR GHALEB PEREZ, CHIDA OBA
7	JULIAN SABATER MIQUEL, HERCA

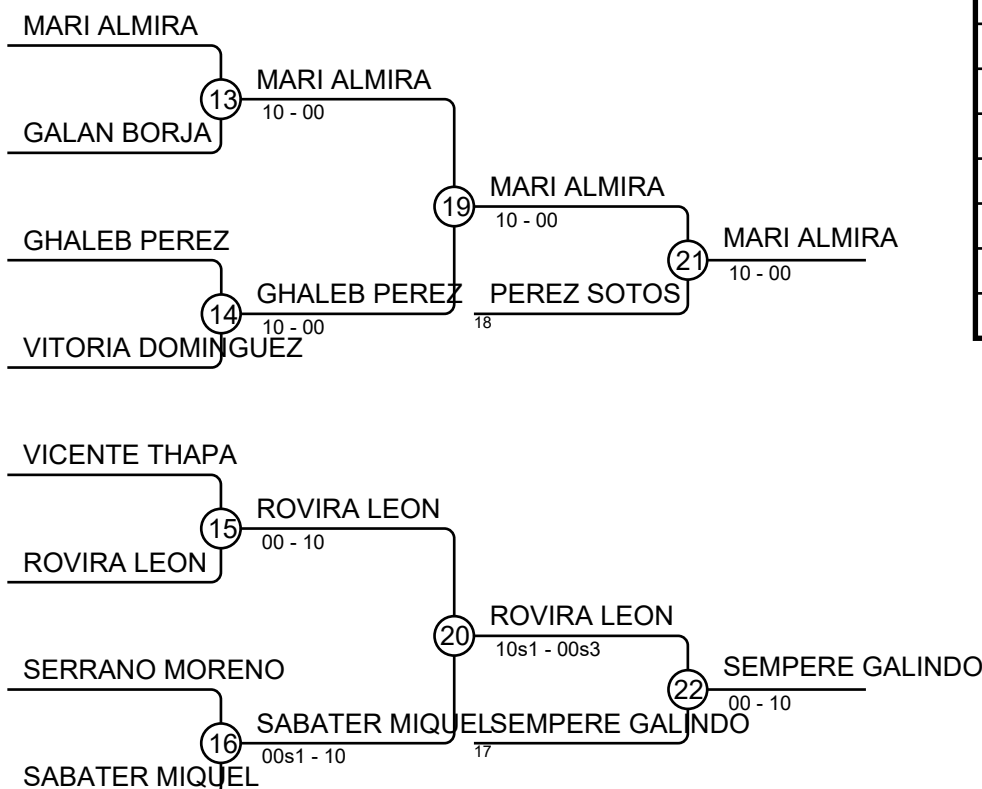

XXXVII Jocs Esportius CV 10/11/18 Valencia Inf M -46

Competidores: 14

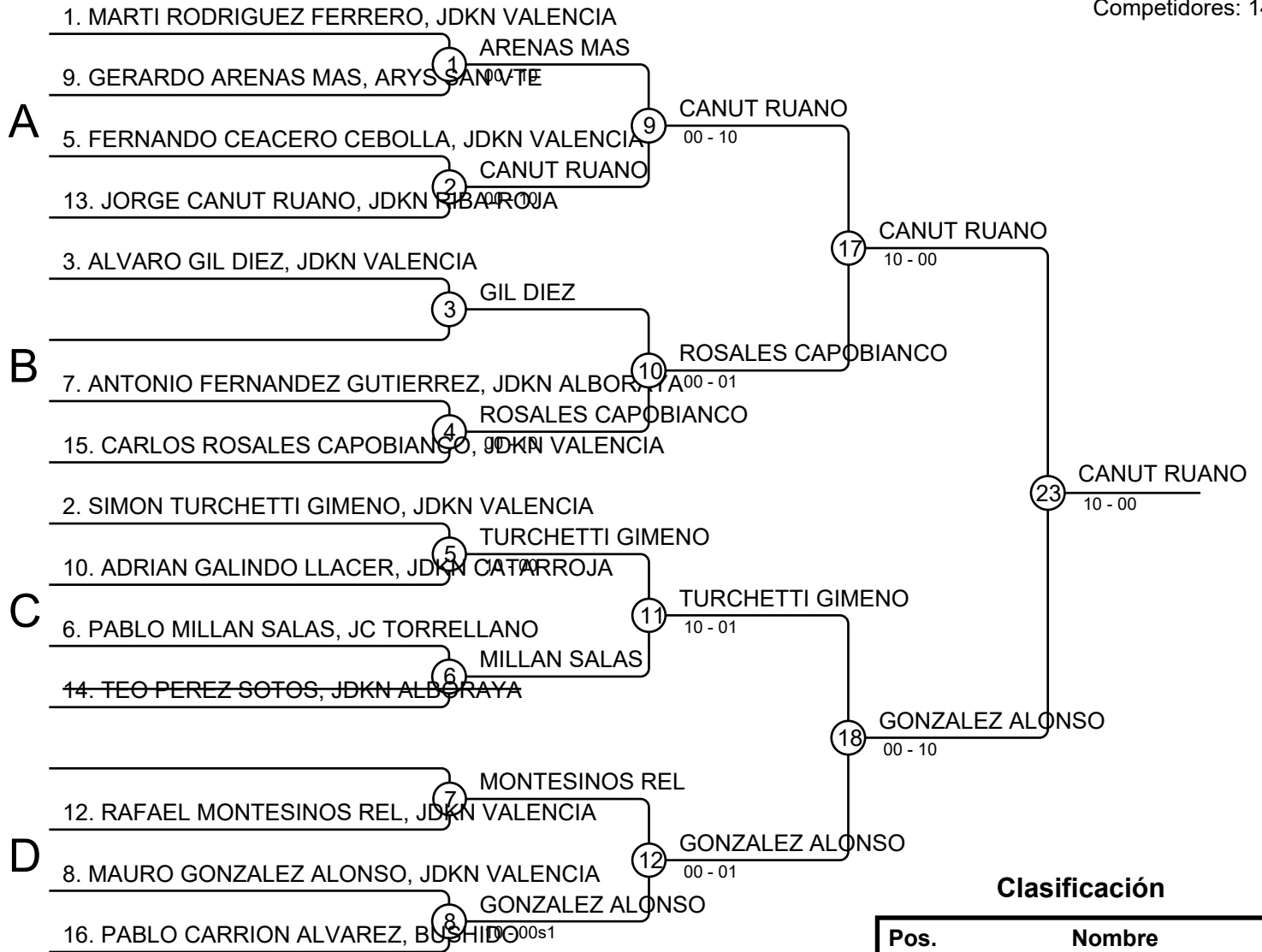

Clasificación

Pos.	Nombre
1	JORGE CANUT RUANO, JDKN RIBARROJA
2	MAURO GONZALEZ ALONSO, JDKN VALENCIA
3	SIMON TURCHETTI GIMENO, JDKN VALENCIA
3	PABLO MILLAN SALAS, JC TORRELLANO
5	ANTONIO FERNANDEZ GUTIERREZ, JDKN ALBORNOJA
5	CARLOS ROSALES CAPOBIANCO, JDKN VALENCIA
7	GERARDO ARENAS MAS, ARYS SAN VTE
7	RAFAEL MONTESINOS REL, JDKN VALENCIA

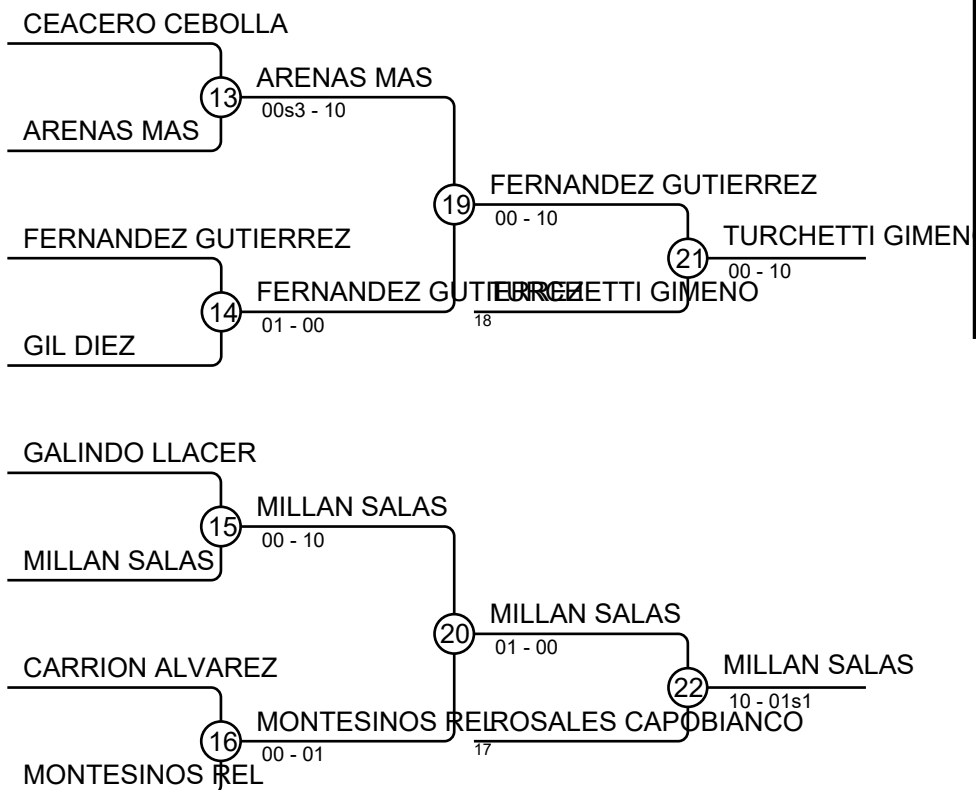

XXXVII Jocs Esportius CV 10/11/18 Valencia Inf M -50

Competidores: 5

1. JAVIER JORDA ALVENTOSA, JDKN VALENCIA

A

5. MARCOS GIMENEZ MORA, JC ALMORADI

1 JORDA ALVENTOSA
00 - 00

B

7. JAVIER BUENROSTRO IBANEZ, JDKN ALBORAYA

2 BUENROSTRO IBANEZ

C

2. NICOLAS ZAMOR ABARCELO, RONIN

3 ZAMOR ABARCELO

D

4. JOAN PALOMARES JUNQUERA, JDKN VALENCIA

4 PALOMARES JUNQUERA

5 JORDA ALVENTOSA
00 - 00

11 PALOMARES JUNQUERA
00 - 00

6 PALOMARES JUNQUERA
00 - 00

Clasificación

Pos.	Nombre
1	JOAN PALOMARES JUNQUERA, JDKN VALENCIA
2	JAVIER JORDA ALVENTOSA, JDKN VALENCIA
3	MARCOS GIMENEZ MORA, JC ALMORADI
3	JAVIER BUENROSTRO IBANEZ, JDKN ALBORAYA
5	NICOLAS ZAMOR ABARCELO, RONIN
7	
7	

GIMENEZ MORA

1
7 GIMENEZ MORA

9 GIMENEZ MORA
00 - 00

6 ZAMOR ABARCELO

3
8

10 BUENROSTRO IBANEZ

5 BUENROSTRO IBANEZ

XXXVII Jocs Esportius CV 10/11/18 Valencia Inf M -55

Competidores: 16

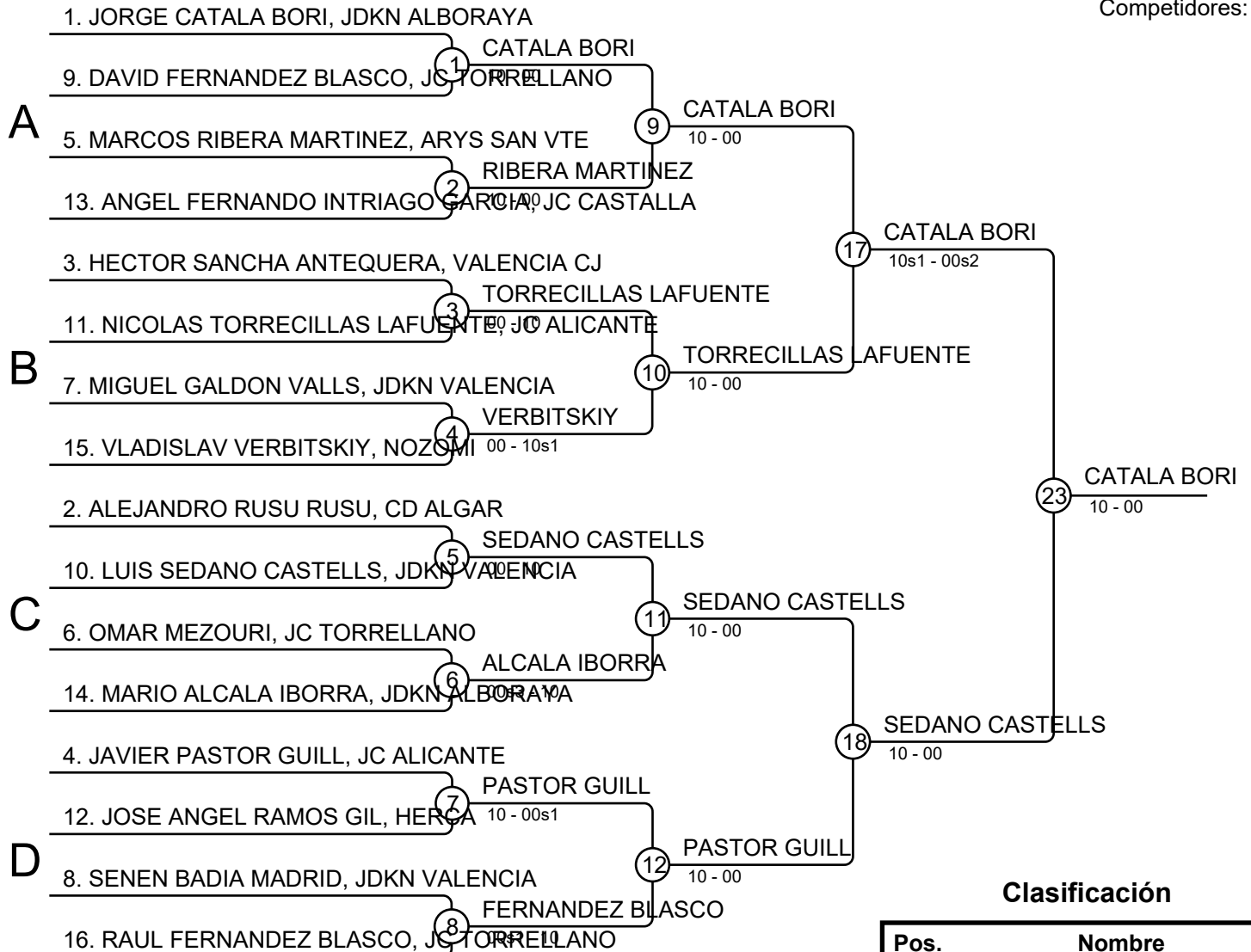

Clasificación

Pos.	Nombre
1	JORGE CATALA BORI, JDKN ALBORAYA
2	LUIS SEDANO CASTELLS, JDKN VALENCIA
3	MARCOS RIBERA MARTINEZ, ARYS SAN VTE
3	NICOLAS TORRECILLAS LAFUENTE, JC ALICANTE
5	JAVIER PASTOR GUILL, JC ALICANTE
5	MARIO ALCALA IBORRA, JDKN ALBORAYA
7	VLADISLAV VERBITSKIY, NOZOMI
7	JOSE ANGEL RAMOS GIL, HERCA

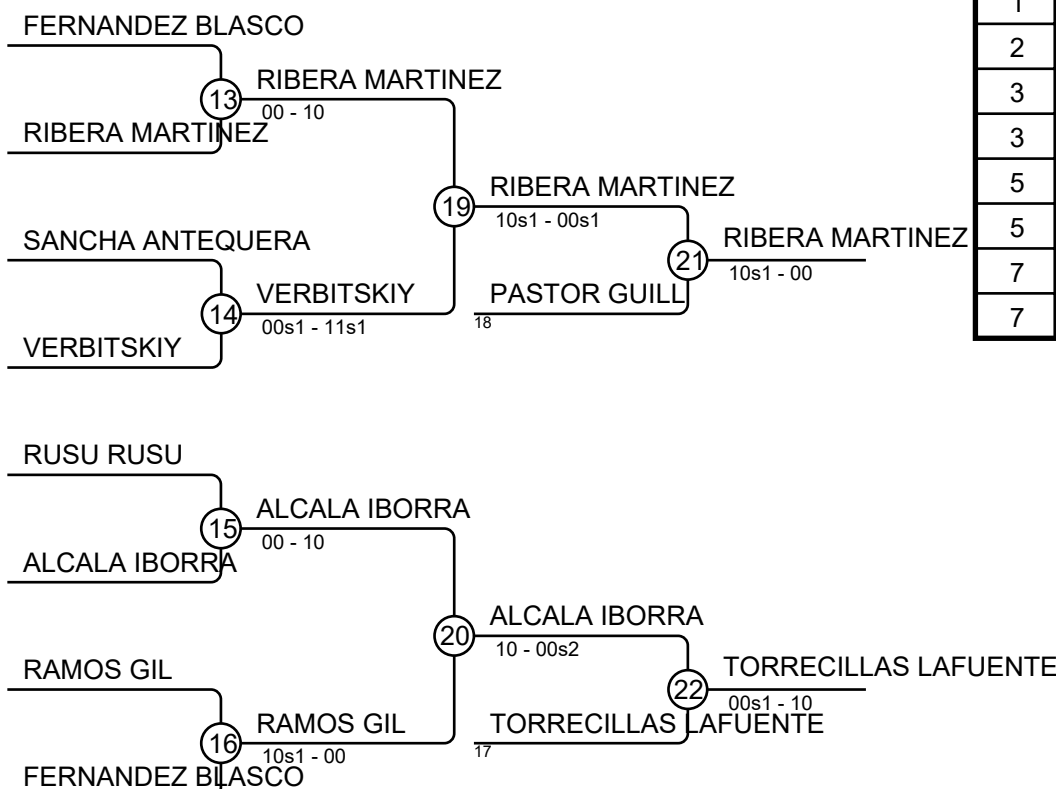

XXXVII Jocs Esportius CV 10/11/18 Valencia Inf M -60

Competidores: 11

1. IKER SPOONER SANCHEZ, NOZOMI

A

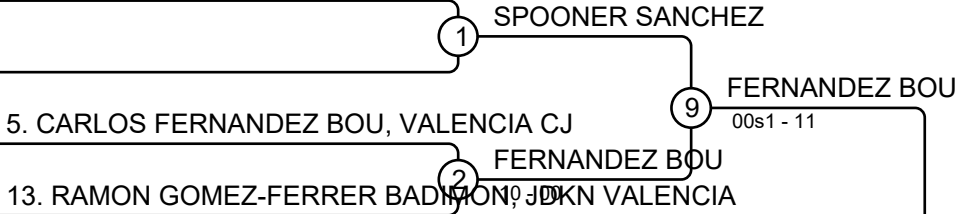

B

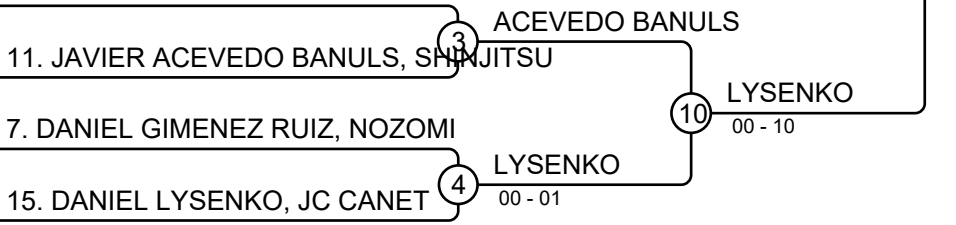

C

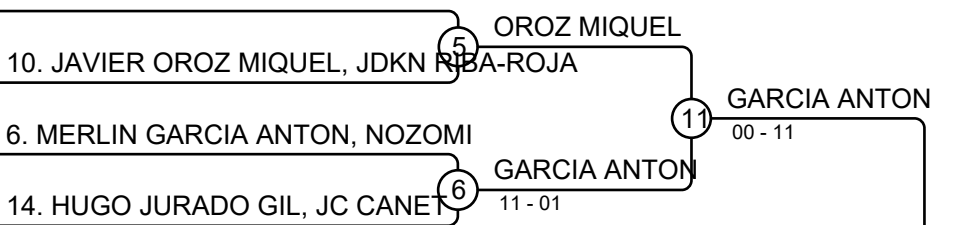

D

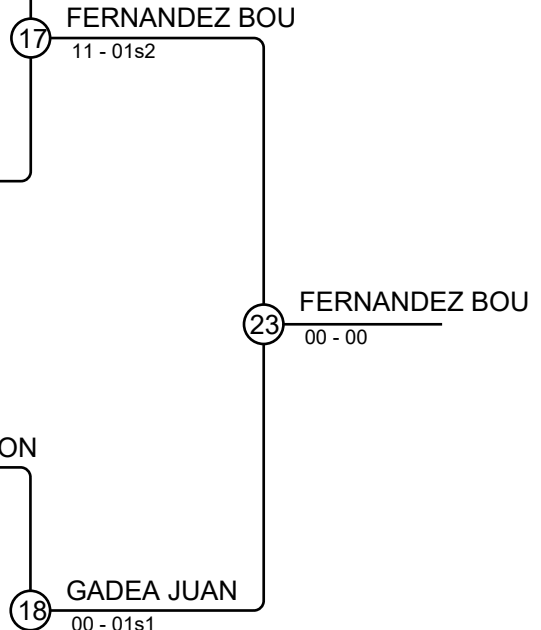
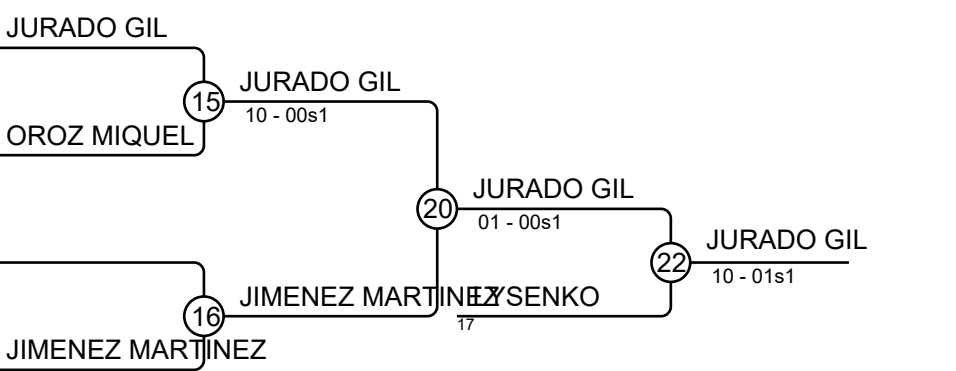
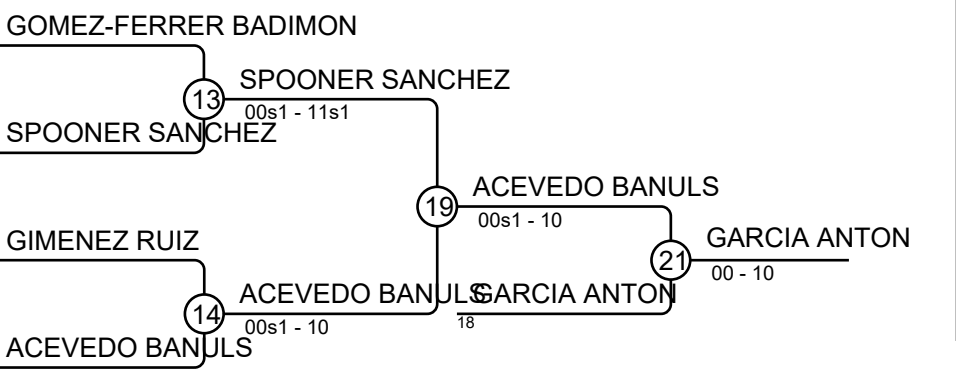
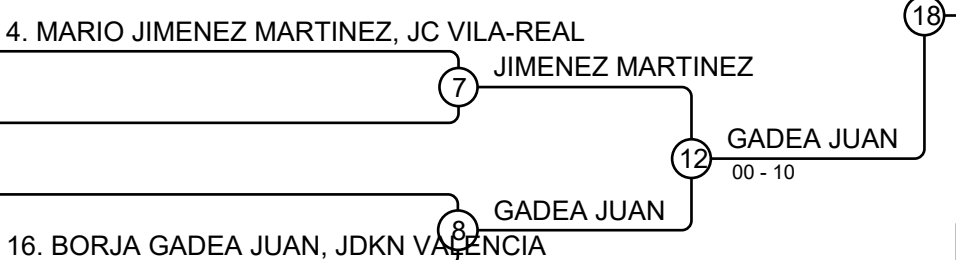

Clasificación

Pos.	Nombre
1	CARLOS FERNANDEZ BOU, VALENCIA CJ
2	BORJA GADEA JUAN, JDKN VALENCIA
3	MERLIN GARCIA ANTON, NOZOMI
3	HUGO JURADO GIL, JC CANET
5	JAVIER ACEVEDO BANULS, SHINJITSU
5	DANIEL LYSENKO, JC CANET
7	IKER SPOONER SANCHEZ, NOZOMI
7	MARIO JIMENEZ MARTINEZ, JC VILA-REAL

XXXVII Jocs Esportius CV 10/11/18 Valencia Inf M -66

Competidores: 11

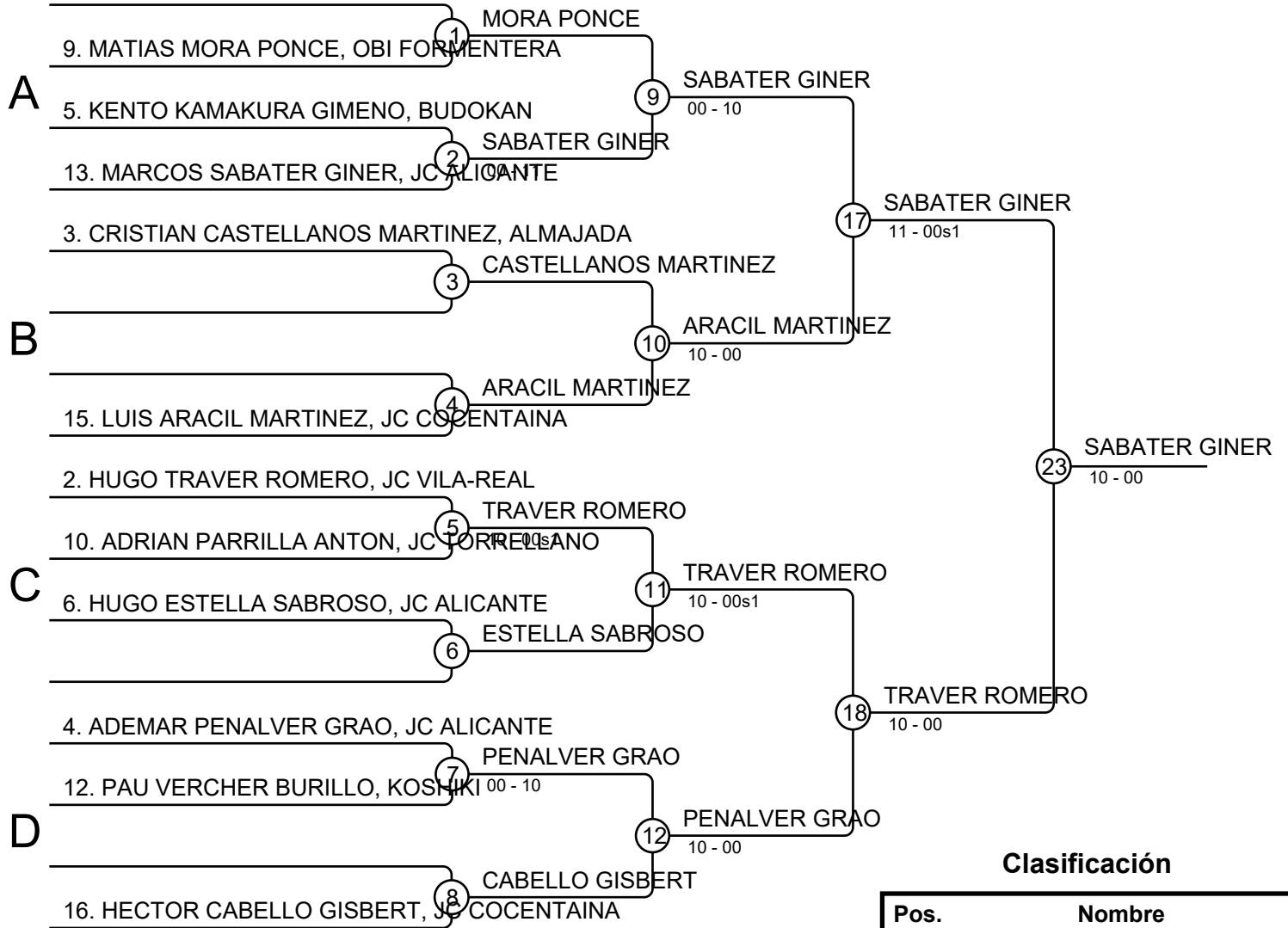

Clasificación

Pos.	Nombre
1	MARCOS SABATER GINER, JC ALICANTE
2	HUGO TRAVER ROMERO, JC VILA-REAL
3	ADEMAR PENALVER GRAO, JC ALICANTE
3	LUIS ARACIL MARTINEZ, JC COCENTAINA
5	KENTO KAMAKURA GIMENO, BUDOKAN
5	ADRIAN PARRILLA ANTON, JC TORRELLANO
7	CRISTIAN CASTELLANOS MARTINEZ, ALMAJADA
7	PAU VERCHER BURILLO, KOSHIKI

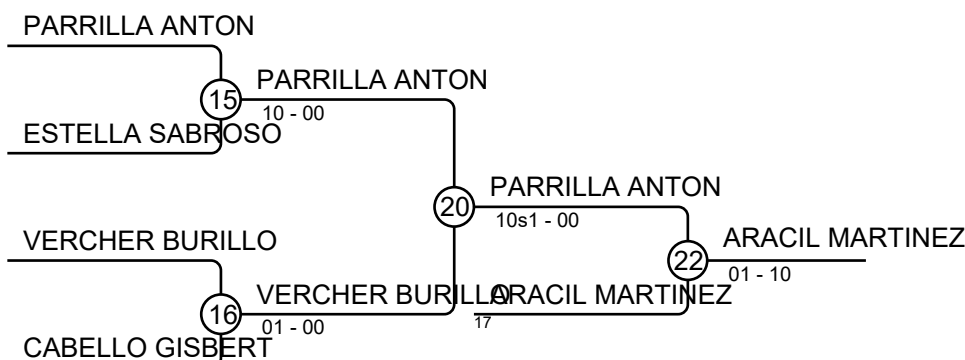
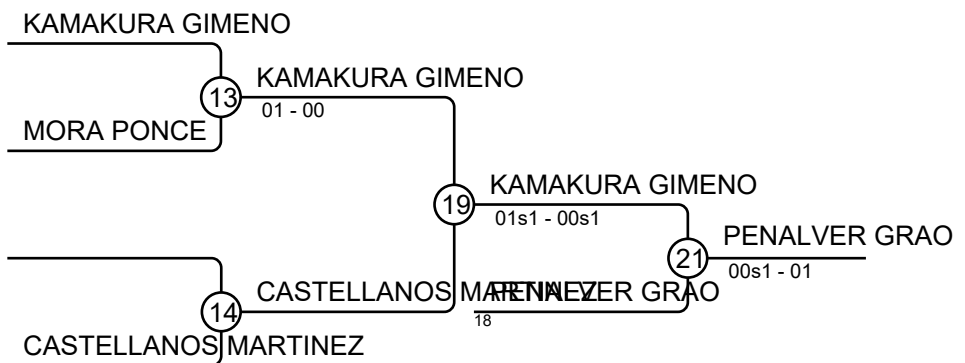

XXXVII Jocs Esportius CV 10/11/18 Valencia Inf M +66

Competidores: 5

1. AMINE ABDELLI DURO, ESPORTIU

A

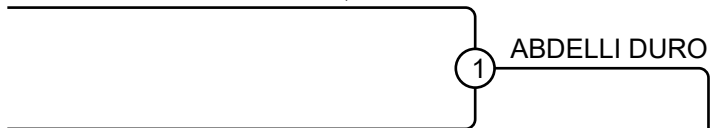

3. ISMAEL ALEIXANDRE PEREZ, VALENCIA CJ

B

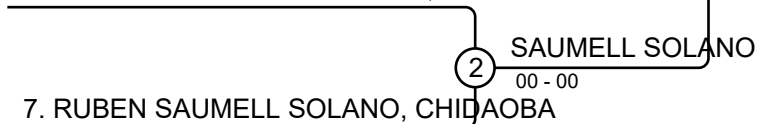

6. PABLO CALDERON LASO, JDN VALENCIA

C

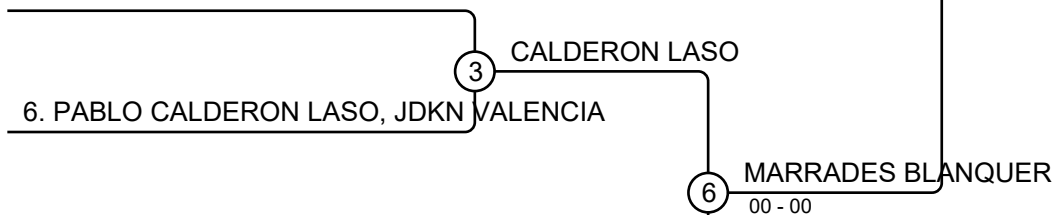

8. JOAN MARRADES BLANQUER, JC ALZIRA

D

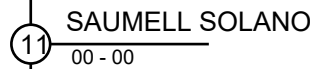
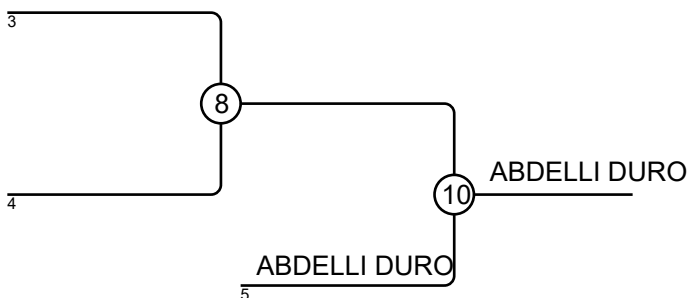
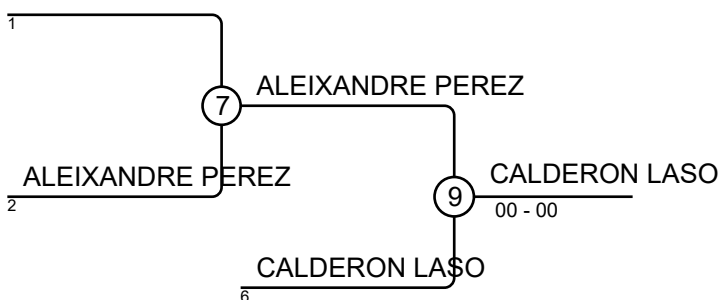

Clasificación

Pos.	Nombre
1	RUBEN SAUMELL SOLANO, CHIDA OBA
2	JOAN MARRADES BLANQUER, JC ALZIRA
3	PABLO CALDERON LASO, JDN VALENCIA
3	AMINE ABDELLI DURO, ESPORTIU
5	ISMAEL ALEIXANDRE PEREZ, VALENCIA CJ
5	
7	
7	