

Super Copa de Espanya Cadete Alicante 2018

Alicante (VAL), 10 Mar 2018

-50 kg

26 Judoka

POOL A

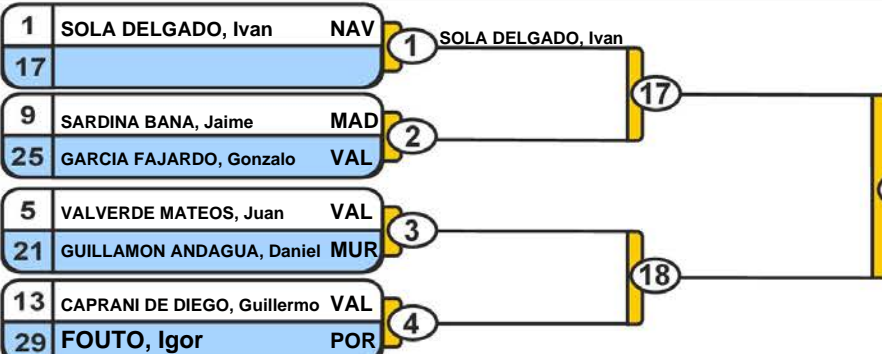

POOL A Winner / Ganador
Vainqueur / Sieger

POOL B

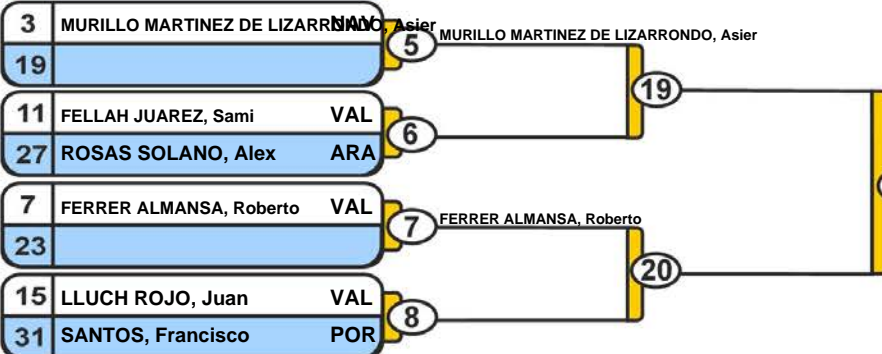

POOL B Winner / Ganador
Vainqueur / Sieger

POOL C

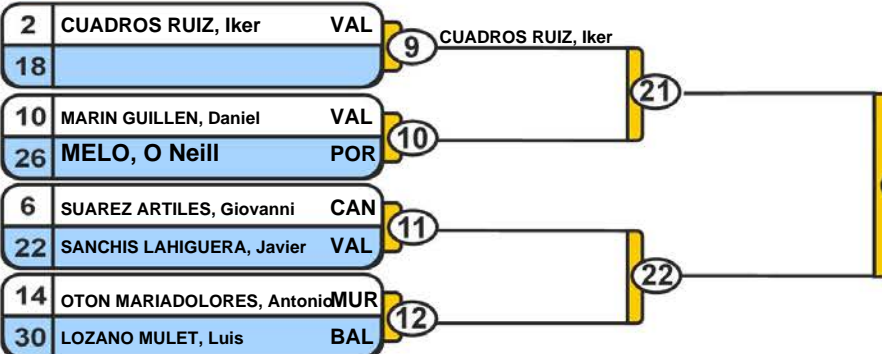

POOL C Winner / Ganador
Vainqueur / Sieger

POOL D

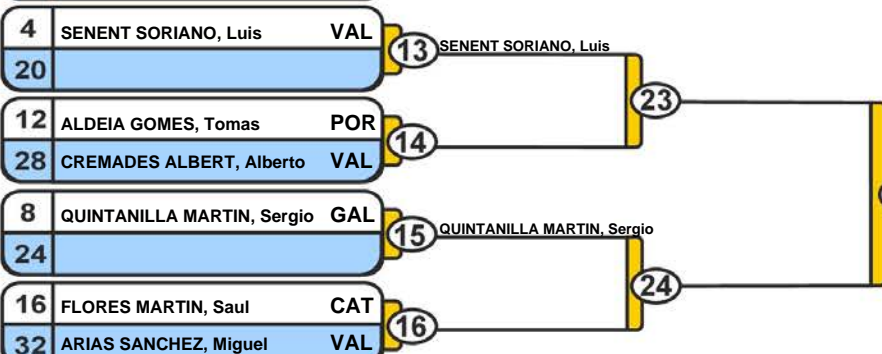

POOL D Winner / Ganador
Vainqueur / Sieger

1.

43

Results

Résultat / Platzierungen / Resultados

- 1.
- 2.
- 3.
- 3.
- 5.
- 5.
- 7.
- 7.

Trostrunde / Repechage / Ronda de consolación

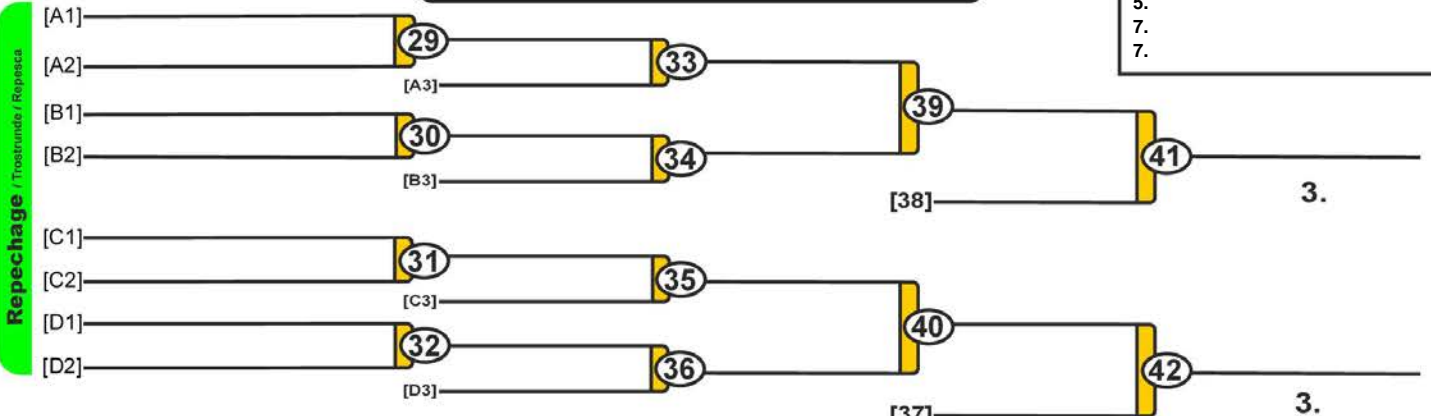

Super Copa de Espanya Cadete Alicante 2018

Alicante (VAL), 10 Mar 2018

-55 kg

39 Judoka

POOL A

1	AZNAL SANTAREN, Alexis	MAD
33		
17		
49		
9	MARQUES, Joao	POR
41	TALTAVULL MARI, Damia	BAL
25	CASANOVA GAGO, Juan	VAL
57		
5	MANUKYAN, Rafayel	VAL
37		
21		
53		
13	CALAFELL CASAJUANA, Marti	CAT
45	BENITEZ, Joao	POR
29	SANMARTIN GRASA, Jesus	ARA
61	BLANQUEZ GAMEZ, David	VAL

1	AZNAL SANTAREN, Alexis
33	
2	
49	
3	
34	CASANOVA GAGO, Juan
4	
5	MANUKYAN, Rafayel
35	
6	
50	
7	
36	
8	

POOL B

3	MARTIN GOMEZ, Asier	CLE
35		
19		
51		
11	LOPEZ AGUADO, Marcos	CTB
43	HORMAR, Rudi Lucian	ARA
27	TABUENCA LINDE, Diego	MAD
59	BENY RODRIGUEZ, Javier	VAL
7	HIRUELAS MARTINEZ, Pablo	MAD
39		
23		
55		
15	TEBAR ESCORCIA, Pablo	VAL
47	HERRERO HERRERA, Alex	CAT
31	COUTO, Sandro	POR
63	GALAN LUCAS, Jorge	VAL

9	MARTIN GOMEZ, Asier
37	
10	
51	
11	
38	
12	
13	HIRUELAS MARTINEZ, Pablo
39	
14	
52	
15	
40	
16	

POOL C

2	FERRER CASTILLO, Diego	ARA
34		
18		
50		
10	GIMENO TRICOT, David	VAL
42	MARTINEZ GONZALEZ, Miguel Angel	CLE
26	MARTINEZ GIMENEZ, Nicolas	MUR
58	CORTADO RUEDA, Jose	VAL
6	SAIZ JUAN, Hugo	MAD
38		
22		
54		
14	PEREZ ACEDO, Adria	CAT
46	ALMEIDA, Miguel	POR
30	CERVERA CANOS, Marc	VAL
62	OBREGON MUNOZ, Felix	RIO

17	FERRER CASTILLO, Diego
41	
18	
53	
19	
42	
20	
21	SAIZ JUAN, Hugo
43	
22	
54	
23	
44	
24	

POOL D

4	PORRAS FERREIRO, Gaizka	VAL
36		
20		
52		
12	BERMEJO BASURDE, Unai	VAS
44	ANTON LOZANO, Isaac	VAL
28	LLULL RIERA, Lluis	BAL
60	STOYKOV, Martin	CAT
8	GARCIA VICENTE, Mateo	MAD
40		
24		
56		
16	SANCHA ANTEQUERA, Joel	VAL
48	GONZALEZ PENA, Yelco Raul	CAN
32	CRUZ ALT, Dominique	CAT
64	BIDARRA, Bruno	POR

25	PORRAS FERREIRO, Gaizka
45	
26	
55	
27	
46	
28	
29	GARCIA VICENTE, Mateo
47	
30	
56	
31	
48	
32	

Repechage

Trostrunde / Repechage / Ronda de consolación

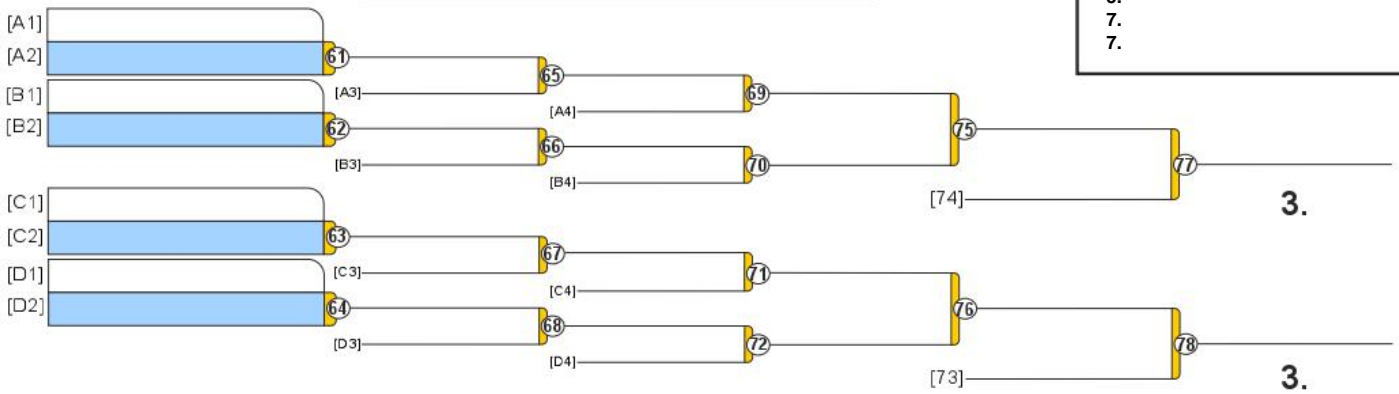

POOL A Winner / Ganador / Vainqueur / Sieger

POOL B Winner / Ganador / Vainqueur / Sieger

POOL C Winner / Ganador / Vainqueur / Sieger

POOL D Winner / Ganador / Vainqueur / Sieger

1.

Results

Résultat / Platzierungen / Resultados

- 1.
- 2.
- 3.
- 3.
- 5.
- 5.
- 7.
- 7.

Super Copa de Espanya Cadete Alicante 2018

Alicante (VAL), 10 Mar 2018

A/B

-60 kg
51 Judoka

POOL A

1	ESTEVAS-GUILMAIN MORAN, Javier	VAL	1	ESTEVAS-GUILMAIN MORAN, Javier	65
65			2		
33			3		
97			4		
17			5		
81			6		
49			7		
113			8		
9	LUBIAN GOMEZ, Pablo	AND	9	MASDEU FERRE, Arnau	69
73	LORENTE PALANCA, Sergio	VAL	10		
41	ALVAREZ OUDDAI, Adam	VAL	11		
105			12		
25	SIERRA SOLER, Mario	MUR	13	GALINDO MUINOS, Ivan	71
89			14	PEREZ AGUEDA, Rodrigo	71
57	MORALES ALVAREZ, Victor Manuel	BAI	15	NIETO VILLAR, Asier	72
121			16	CORREIA, Iuri	72
5	MASDEU FERRE, Arnau	CAT	17	KOVALCHUK, Igor	72
69			18	LEON LEON, Aray	72
37					
101					
21					
85					
53					
117					
13	GALINDO MUINOS, Ivan	VAL			
77	PEREZ AGUEDA, Rodrigo	ARA			
45	NIETO VILLAR, Asier	NAV			
109	CORREIA, Iuri	POR			
29	KOVALCHUK, Igor	VAL			
93					
61	LEON LEON, Aray	CAN			
125					

POOL B

3	GALLEGO SAEZ, Daniel	MAD	17	GALLEGO SAEZ, Daniel	73
67			18		
35			19		
99			20		
19			21		
83			22		
51			23		
115			24		
11	MARIN LOPEZ, Aaron	AND	25	ALONSO CEREZUELA, Manuel	77
75	CERVERA JIMENEZ, Aaron	CAT	26		
43	NOZAL GARCIA, Gonzalo	VAL	27		
107			28		
27	LEON, Igor	NAV	29	SANTAS COLOMER, Juan	79
91			30	FERNANDEZ ESPANA, Ivan	79
59	PARDO PEREZ, Salvador	VAL	31	MONTESINOS REL, Sergio	80
123			32		
7	ALONSO CEREZUELA, Manuel	ARA			
71					
39					
103					
23					
87					
55					
119					
15	SANTAS COLOMER, Juan	VAL			
79	FERNANDEZ ESPANA, Ivan	MUR			
47	MONTESINOS REL, Sergio	VAL			
111	CORRECHER VILLALBA, Biel	CAT			
31	GOTTHEINER, Arthur	POR			
95					
63					
127					

Trostrunde / Repechage / Ronda de consolación

Repechage / Trostrunde / Ronda de consolación

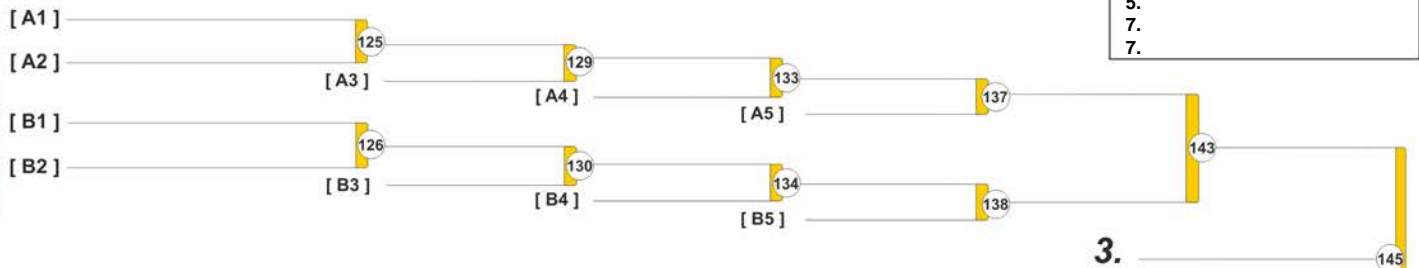

3.

Results

Resultat / Platzierungen / Resultados

- 1.
- 2.
- 3.
- 5.
- 7.
- 7.

Super Copa de Espanya Cadete Alicante 2018

Alicante (VAL), 10 Mar 2018

C/D

-60 kg
51 Judoka

POOL C

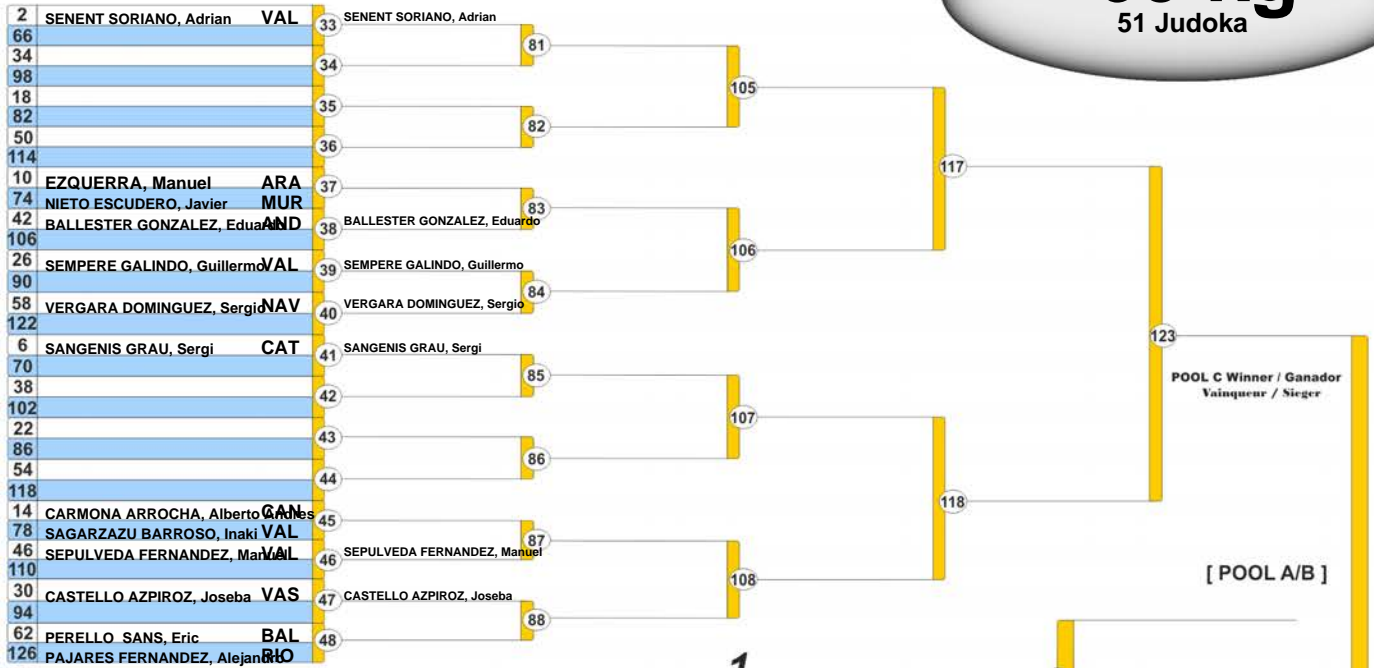

POOL D

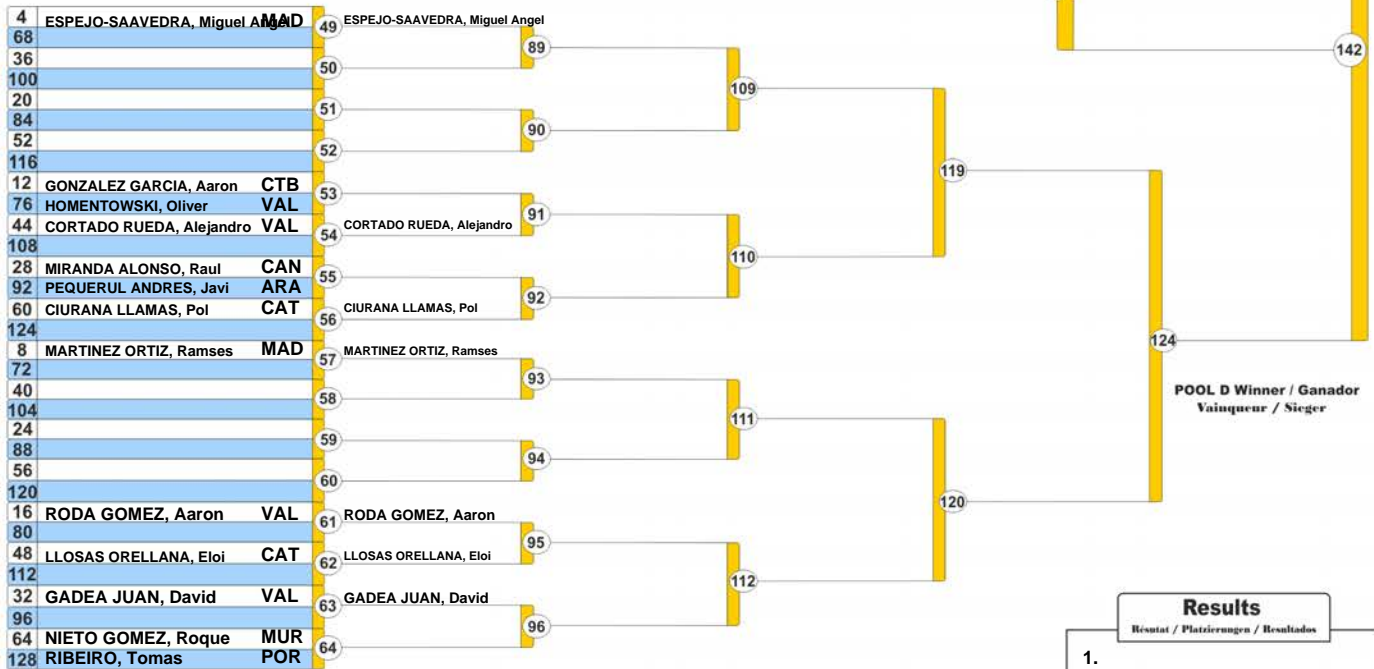

Trostrunde / Repechage / Ronda de consolación

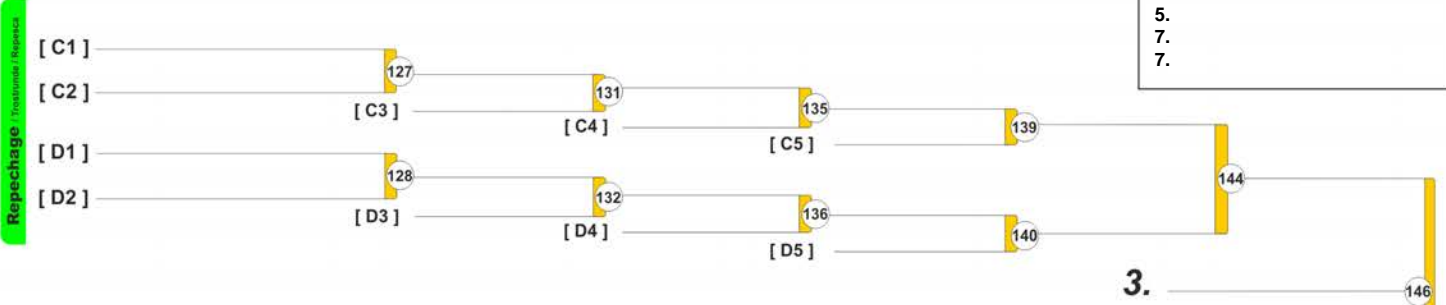

Results
Resultat / Platzierungen / Resultados

- 1.
- 2.
- 3.
- 5.
- 7.

Super Copa de Espanya Cadete Alicante 2018

Alicante (VAL), 10 Mar 2018

A/B

-66 kg
49 Judoka

POOL A

1	GARCIA OBENSA, Sergio	ARA	1	GARCIA OBENSA, Sergio	65
65			2		
33			3		
97			4		
17			5		
81			6	BERTOMEU PEREZ, Roberto	67
49			7		
113			8	CABRAL ORTEGO, Guillermo	68
9	SANGIL SERRANO, Pablo	BAL	9	NAVAL MARQUES, Marc	69
73	ORTIZ BELDA, Oscar	VAL	10		
41	BERTOMEU PEREZ, Roberto	VAL	11		
105			12		
25	ALARCON BELLERINO, Marc	CAT	13	PENALVER FERNANDEZ, Jorge	71
89	SANCHEZ GARCIA, Conrado	MUR	14	MARTINEZ MANSO, Victor	71
57	CABRAL ORTEGO, Guillermo	CAN	15	CAMPOS MORENO, Luis Felipe	72
121			16	MANEUS BERNAL, Marco Antonio	72
5	NAVAL MARQUES, Marc	ARA			
69					
37					
101					
21					
85					
53					
117					
13	PENALVER FERNANDEZ, Jorge	MUR			
77	HERNANDEZ RODRIGUEZ, Jose Carlos	CAN			
45	MARTINEZ MANSO, Victor	VAL			
109					
29	CAMPOS MORENO, Luis Felipe	MAD			
93					
61	MANEUS BERNAL, Marco Antonio	VAL			
125					

POOL B

3	MERINO MENCIA, Unai	VAS	17	MERINO MENCIA, Unai	73
67			18		
35			19		
99			20		
19			21	ESCRIVA PEREZ, Gabriel	75
83			22	BUENO INFANTE, Carlos	75
51			23	GARRIDO MARTIN, Mario	76
115			24	ACOSTA JORGE, Javier	76
11	ESCRIVA PEREZ, Gabriel	BAL	25	BARRAMEDA MARTIN, Sergio	77
75	OLIVER BELANDO, Daniel	VAL	26		
43	BUENO INFANTE, Carlos	VAL	27		
107			28		
27	GARRIDO MARTIN, Mario	MAD	29	MOYA RODRIGUEZ, Alejandro	79
91			30	MARTINEZ GIMENEZ, Pablo	79
59	ACOSTA JORGE, Javier	CAN	31	TILIDZE, Grigoli	80
123			32	AMUTIO GONZALEZ, Jose Maria	80
7	BARRAMEDA MARTIN, Sergio	CAN			
71					
39					
103					
23					
87					
55					
119					
15	MOYA RODRIGUEZ, Alejandro	CAT			
79	DOMINGUEZ CACHO, Jose Ignacio	MUR			
47	MARTINEZ GIMENEZ, Pablo	MUR			
111					
31	TILIDZE, Grigoli	VAL			
95					
63	AMUTIO GONZALEZ, Jose Maria	AND			
127					

Repechage / Trostrunde / Ronda de consolación

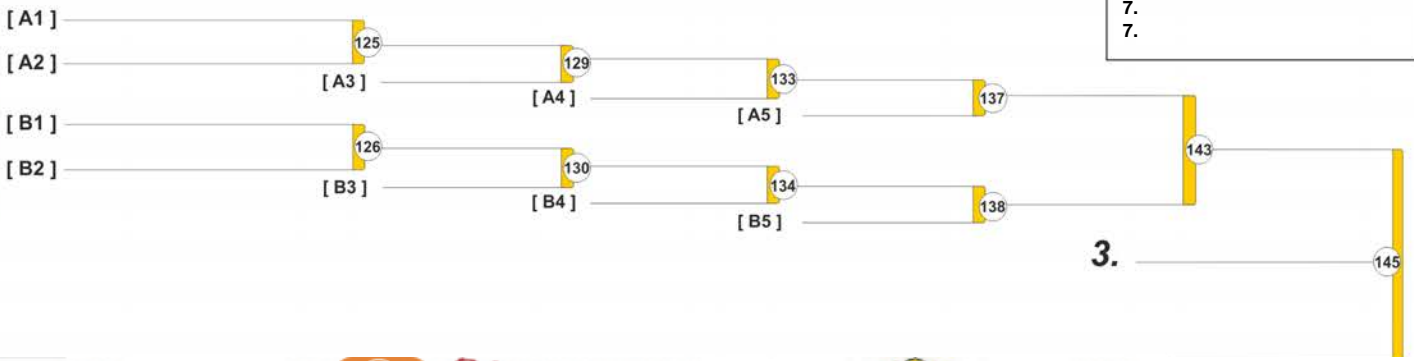

Results	
Resultat / Platzierungen / Resultados	
1.	
2.	
3.	
3.	
5.	
7.	
7.	

Super Copa de Espanya Cadete Alicante 2018

Alicante (VAL), 10 Mar 2018

C/D

-66 kg
49 Judoka

POOL C

2	GARCIA SANRAFAEL, Marc	CAT	33	GARCIA SANRAFAEL, Marc	81			
66			34					
34			35					
98			36					
18			37	MADRID MARTINEZ, Juan	MUR	37	MADRID MARTINEZ, Juan	83
82			38	MUCI NATALIZIO, Leonardo	VAL	38	MUCI NATALIZIO, Leonardo	83
50			39	MARTIN DE LEON, Adrian	CAN	39	MARTIN DE LEON, Adrian	84
114			40	VIDAL ARMENDARIZ, Mikel	BAL	40	VIDAL ARMENDARIZ, Mikel	84
10	MADRID MARTINEZ, Juan	MUR	41	VEGA GOMEZ, Fernando	CAN	41	VEGA GOMEZ, Fernando	85
74	KARATAYEU, Ivan	VAL	42			42		
42	MUCI NATALIZIO, Leonardo	VAL	43			43		
106			44			44		
26	MARTIN DE LEON, Adrian	CAN	45	SORIANO RODRIGUEZ, Jaime	VAL	45	SORIANO RODRIGUEZ, Jaime	87
90			46	FERNANDEZ, Oscar	ARA	46	FERNANDEZ, Oscar	87
58	VIDAL ARMENDARIZ, Mikel	BAL	47	PRADAS DE LAS HERAS, Iker	CAT	47	PRADAS DE LAS HERAS, Iker	88
122			48	OGAYAR SANCHEZ, Emilio	MUR	48	OGAYAR SANCHEZ, Emilio	88
6	VEGA GOMEZ, Fernando	CAN						
70								
38								
102								
22								
86								
54								
118								
14	SORIANO RODRIGUEZ, Jaime	VAL						
78								
46	FERNANDEZ, Oscar	ARA						
110	RODRIGUEZ BUENO, Fernando	VAL						
30	PRADAS DE LAS HERAS, Iker	CAT						
94								
62	OGAYAR SANCHEZ, Emilio	MUR						
126								

POOL D

4	GOMEZ ROMO, Jorge	CLM	49	GOMEZ ROMO, Jorge	89			
68			50					
36			51					
100			52					
20			53	MORALES PEREZ, Naucet Alejandro	MUR	53	MORALES PEREZ, Naucet Alejandro	91
84			54	FERNANDEZ LLORIS, Emilio	VAL	54	FERNANDEZ LLORIS, Emilio	91
52			55	FILIPE DA COSTA VENANCIO, Ricardo	FOR	55	FILIPE DA COSTA VENANCIO, Ricardo	92
116			56	XIA, Jhonnie	MAD	56	XIA, Jhonnie	92
12	MORALES PEREZ, Naucet Alejandro	MUR	57	FLETA BERAZA, Jorge	VAS	57	FLETA BERAZA, Jorge	93
76	MENDEZ LEON, Guaire	CAN	58			58		
44	FERNANDEZ LLORIS, Emilio	VAL	59			59		
108			60			60		
28	FILIPE DA COSTA VENANCIO, Ricardo	FOR	61	BAIXAULI ARSON, Marc	VAL	61	BAIXAULI ARSON, Marc	95
92			62	GARCIA EURREUTIA, Alejandro	MUR	62	GARCIA EURREUTIA, Alejandro	95
60	XIA, Jhonnie	MAD	63	ROJO PORQUET, Oriac	CAT	63	ROJO PORQUET, Oriac	96
124			64	MONTES ALONSO, Ruben	VAL	64	MONTES ALONSO, Ruben	96
8	FLETA BERAZA, Jorge	VAS						
72								
40								
104								
24								
88								
56								
120								
16	BAIXAULI ARSON, Marc	VAL						
80	GARCIA EURREUTIA, Alejandro	MUR						
48	ROJO PORQUET, Oriac	CAT						
112								
32	MONTES ALONSO, Ruben	VAL						
96								
64	ANGLES PLANAS, Pau	ARA						
128								

Repechage / Trostrunde / Ronda de consolación

[C1]
[C2]
[D1]
[D2]

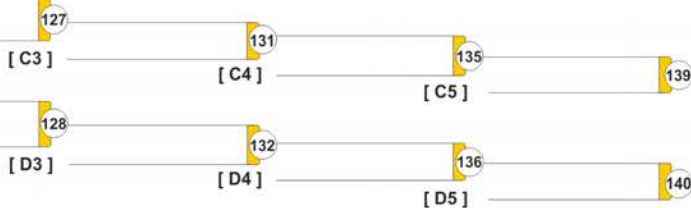

Results	
Resultat / Platzierungen / Resultados	
1.	
2.	
3.	
3.	
5.	
7.	
7.	

3.

146

Super Copa de Espanya Cadete Alicante 2018

Alicante (VAL), 10 Mar 2018

A/B

-73 kg
43 Judoka

POOL A

1	MORALES MESA, Jone	CAN	1	MORALES MESA, Jone
65			65	
33			2	
97			3	
17			4	
81			5	
49			6	JIMENEZ ATIENZAR, Oscar
113			7	CAVERO CARMONA, Ruben
9	MANSO FERNANDEZ, Daniel	MAD	8	LAZAR, Mario
73	TYMCHUK, Iliia	VAL	9	AKIMIDZE, Giorgi
41			10	
105	JIMENEZ ATIENZAR, Oscar	MUR	11	
25	CAVERO CARMONA, Ruben	VAL	12	
89			13	DE GRACIA TENDERO, Ismael
57	LAZAR, Mario	BAL	14	NAVARRO DE BRITO, Miguel
121			15	RUBIO PEREZ, Eduardo
5	AKIMIDZE, Giorgi	RIO	16	HERNANDEZ AGUILAR, Felipe
69				
37				
101				
21				
85				
53				
117				
13	DE GRACIA TENDERO, Ismael	VAL		
77				
45	NAVARRO DE BRITO, Miguel	VAL		
109				
29	RUBIO PEREZ, Eduardo	VAL		
93				
61	HERNANDEZ AGUILAR, Felipe	CAN		
125				

POOL B

3	GIRON HASHINO, Ian	MAD	17	GIRON HASHINO, Ian
67			18	
35			19	
99			20	
19			21	PEREZ DE TUDELA CARREIRAS, Marc
83			22	BAUDRY MONTANE, Arnaud
51			23	OTERO SANTAINES, Jose
115			24	RUANO HANKE, Aimeyacoan
11	PEREZ DE TUDELA CARREIRAS, Marc	VAL	25	RAMIREZ MARTINEZ, Adrian
75			26	
43	BAUDRY MONTANE, Arnaud	CAT	27	
107			28	
27	OTERO SANTAINES, Jose	VAL	29	FERNANDEZ LOPEZ, Javier
91			30	SILVA, Guilherme
59	RUANO HANKE, Aimeyacoan	CAN	31	OROZCO CALLEJA, Ivan
123			32	RUIZ LUENGO, David
7	RAMIREZ MARTINEZ, Adrian	CAN		
71				
39				
103				
23				
87				
55				
119				
15	FERNANDEZ LOPEZ, Javier	VAL		
79				
47	SILVA, Guilherme	POR		
111				
31	OROZCO CALLEJA, Ivan	VAL		
95				
63	RUIZ LUENGO, David	MUR		
127				

Repechage / Trostrunde / Ronda de consolación

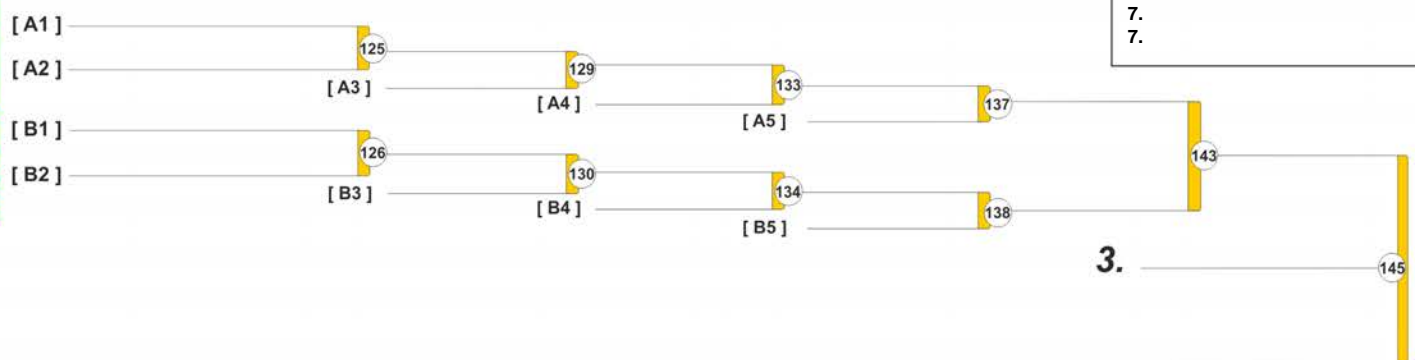

Results	
Resultat / Platzierungen / Resultados	
1.	
2.	
3.	
3.	
5.	
7.	
7.	

Super Copa de Espanya Cadete Alicante 2018

Alicante (VAL), 10 Mar 2018

-81 kg

12 Judoka

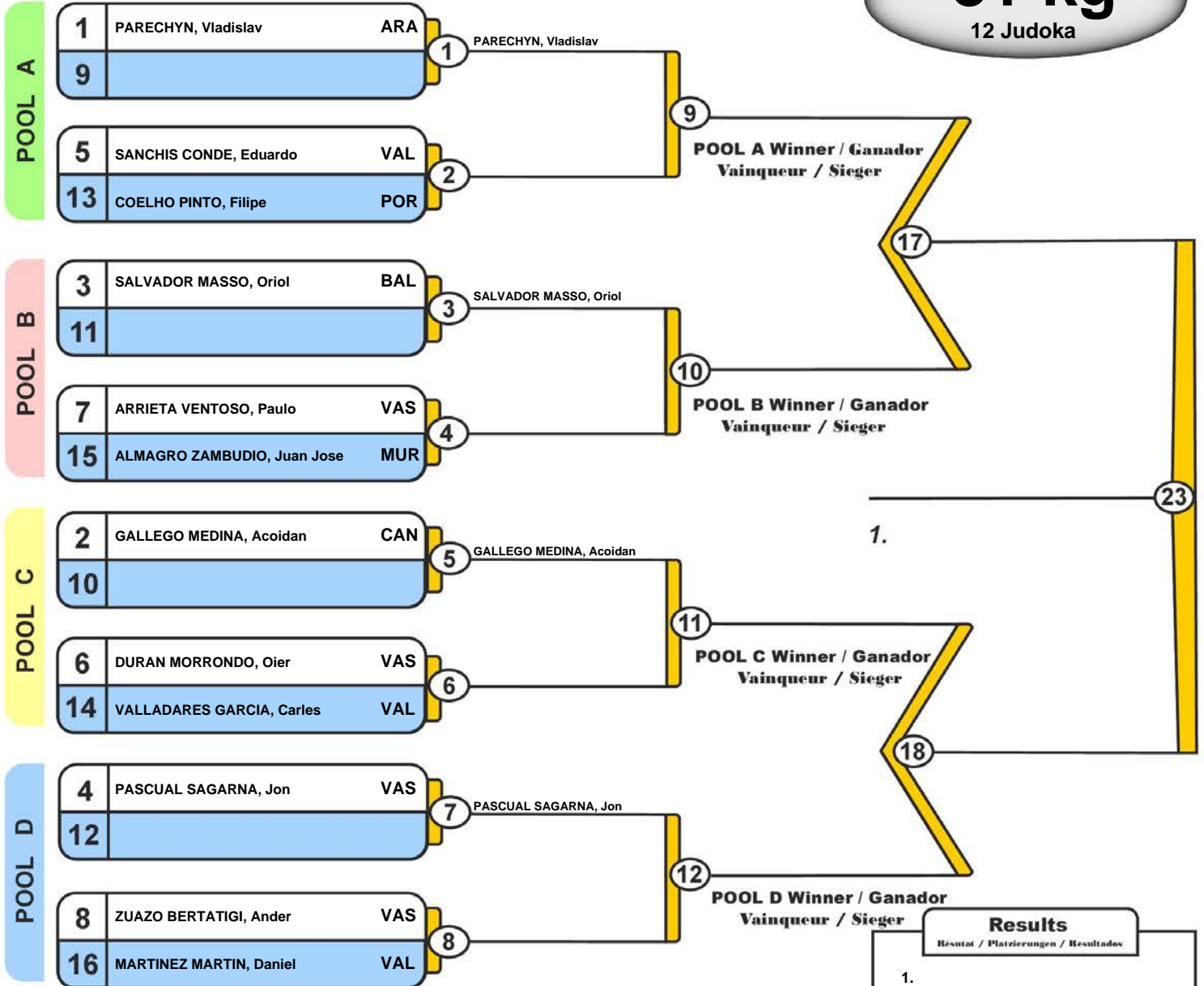

Trostrunde / Repechage / Ronda de consolación

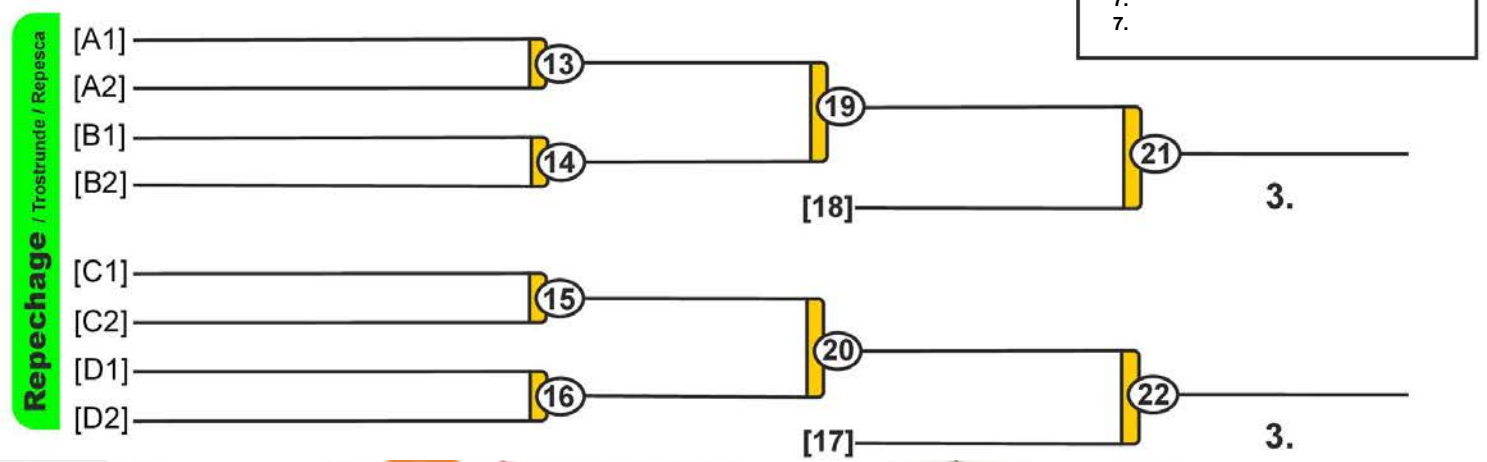

Results	
Resultat / Platzierungen / Resultados	
1.	
2.	
3.	
3.	
5.	
7.	
7.	

Super Copa de Espanya Cadete Alicante 2018

Alicante (VAL), 10 Mar 2018

-90 kg

15 Judoka

POOL A

1	RODRIGUEZ ALVAREZ, Eloy	ARA	1	RODRIGUEZ ALVAREZ, Eloy
17			17	
9			2	
25			25	
5			3	ROMERO DONAT, Carlos
21	ROMERO DONAT, Carlos	VAL	18	
13	IBANEZ PINERO, Alejandro	AND	4	IBANEZ PINERO, Alejandro
29			29	

POOL B

3	RUIZ TORRES, David	CAN	5	RUIZ TORRES, David
19			19	
11			6	
27			27	
7	ALBEROLA VALVERDE, Ivan	VAL	7	MARTINEZ PORTUGUES, Guillen
23	MARTINEZ PORTUGUES, Guillen	CAT	20	
15	PARA CASTEJON, Arturo	MUR	8	PARA CASTEJON, Arturo
31			31	

POOL C

2	REVUELTA GRENADA, Juan Manuel	VAL	9	REVUELTA GRENADA, Juan Manuel
18			21	
10			10	
26			26	
6	GONZALEZ BACIGALUPO, Andres	BAL	11	GASQUET SOSA, Nahuel
22	GASQUET SOSA, Nahuel	CAN	22	
14	SANCHEZ FONTECHA, Angel	MAD	12	SANCHEZ FONTECHA, Angel
30			30	

POOL D

4	ARAMBARRI PENA, Gorka	VAS	13	ARAMBARRI PENA, Gorka
20			23	
12			14	
28			28	
8	CARRERA SALSAMENDI, Amets	VAS	15	TREMINO RAMIREZ, Bryan Steed
24	TREMINO RAMIREZ, Bryan Steed	VAL	24	
16	BAEZA ALCANTARA, Angel	MUR	16	BAEZA ALCANTARA, Angel
32			32	

Trostrunde / Repechage / Ronda de consolación

Repechage

[A1]	29	[A2]	33	[A3]	39	[B1]	30	[B2]	34	[B3]	41
[C1]	31	[C2]	35	[C3]	40	[D1]	32	[D2]	36	[D3]	42

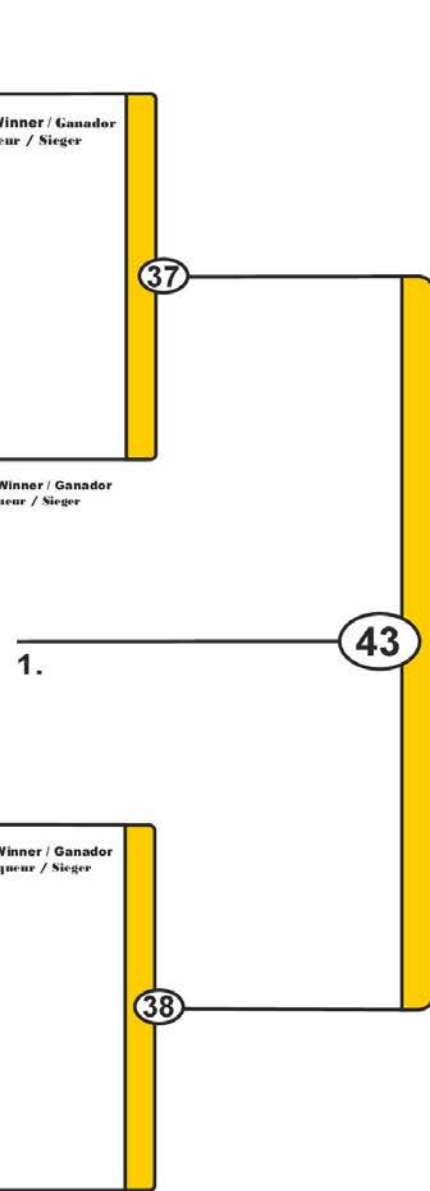

Results	
Resultat / Platzierungen / Resultados	
1.	
2.	
3.	
3.	
5.	
5.	
7.	
7.	

Super Copa de Espanya Cadete Alicante 2018

Alicante (VAL), 10 Mar 2018

+90 kg

4 Judoka

			1	2	3	4	
1	QUEVEDO MORA, David	VAL					0 (0)
2	RIVERO BEN MOHAMED, Israel	CAN					0 (0)
3	MUNOZ IBANEZ, Ricard	CAT					0 (0)
4	LOPEZ LOPEZ, Maxi	VAL					0 (0)

1	QUEVEDO MORA, David	VAL	①
2	RIVERO BEN MOHAMED, Israel	CAN	

3	MUNOZ IBANEZ, Ricard	CAT	②
4	LOPEZ LOPEZ, Maxi	VAL	

1	QUEVEDO MORA, David	VAL	③
3	MUNOZ IBANEZ, Ricard	CAT	

2	RIVERO BEN MOHAMED, Israel	CAN	④
4	LOPEZ LOPEZ, Maxi	VAL	

1	QUEVEDO MORA, David	VAL	⑤
4	LOPEZ LOPEZ, Maxi	VAL	

2	RIVERO BEN MOHAMED, Israel	CAN	⑥
3	MUNOZ IBANEZ, Ricard	CAT	

Final Results

- 1.
- 2.
- 3.

Super Copa de Espanya Cadete Alicante 2018

Alicante (VAL), 10 Mar 2018

-40 kg

7 Judoka

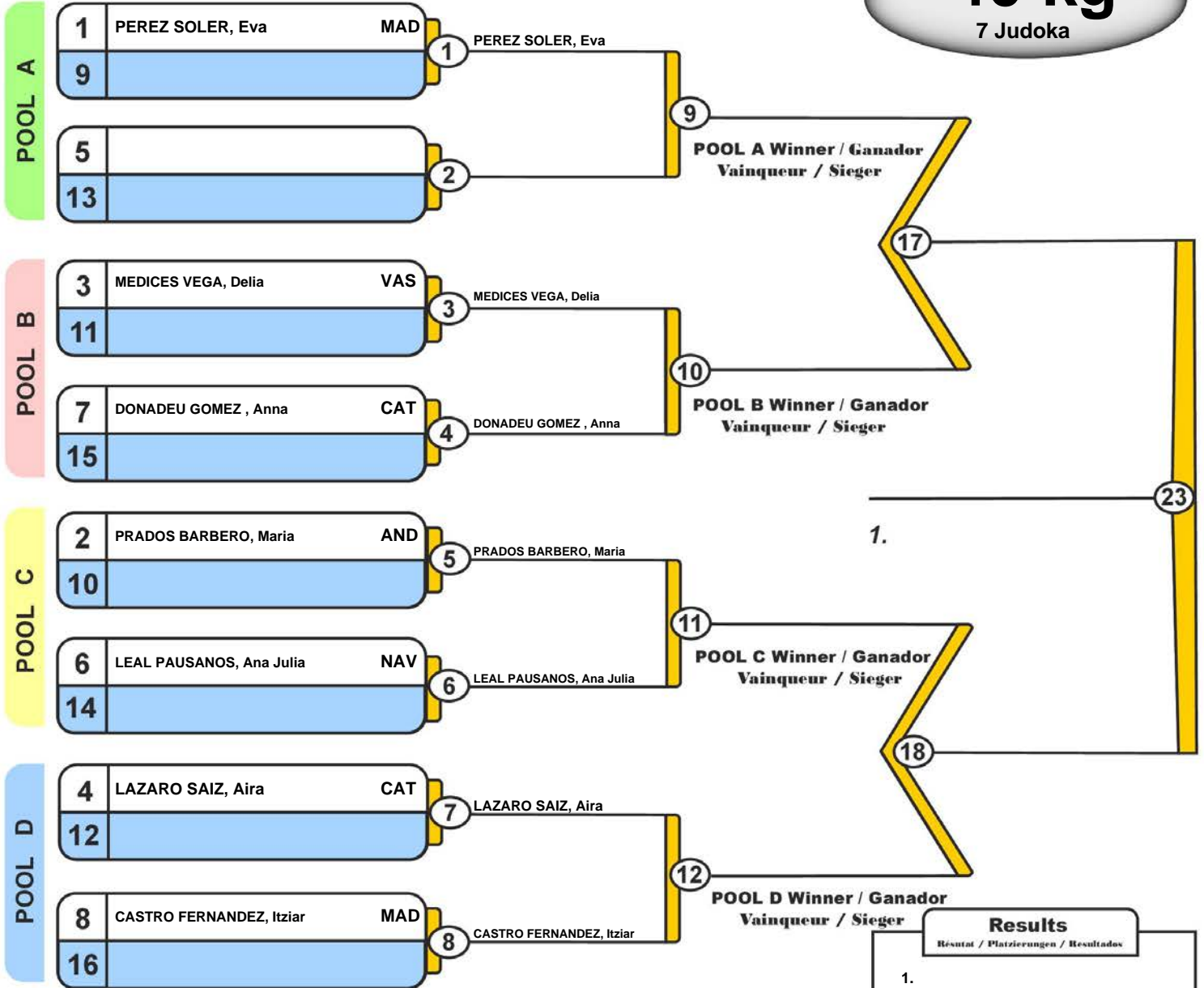

Trostrunde / Repechage / Ronda de consolación

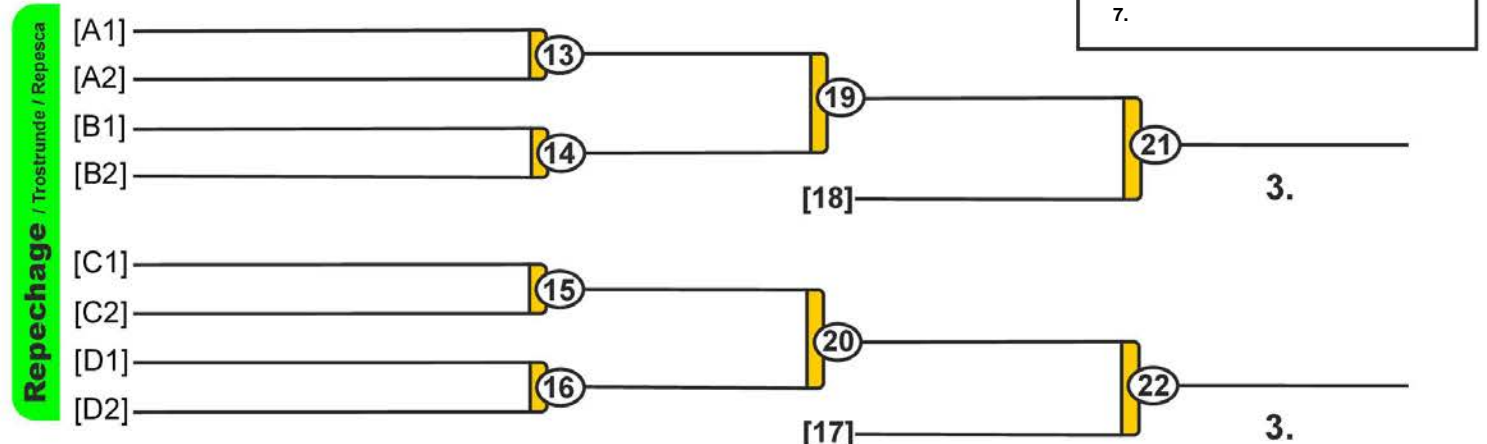

Results	
Resultat / Platzierungen / Resultados	
1.	
2.	
3.	
3.	
5.	
7.	
7.	

Super Copa de Espanya Cadete Alicante 2018

Alicante (VAL), 10 Mar 2018

-44 kg

10 Judoka

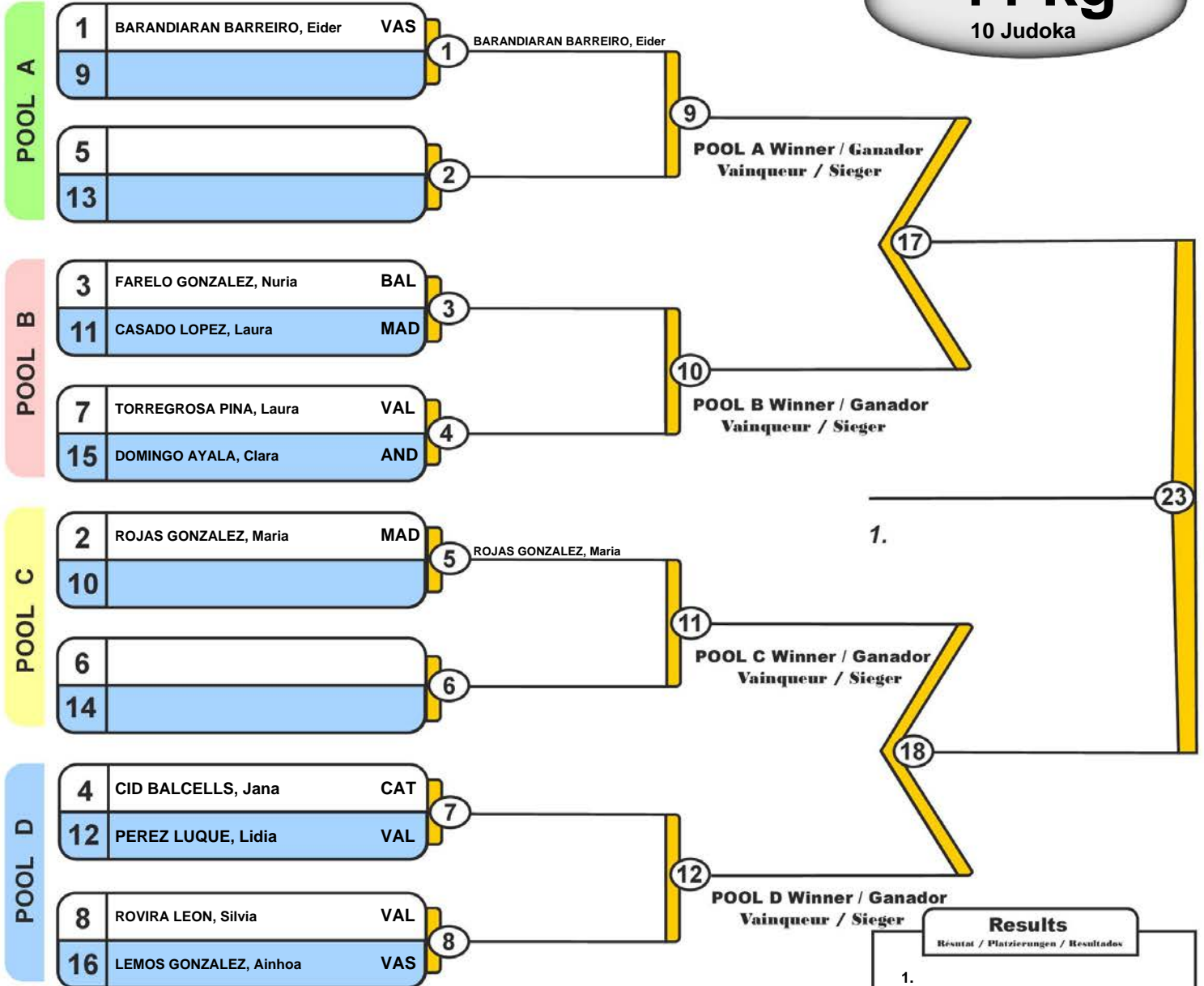

Trostrunde / Repechage / Ronda de consolación

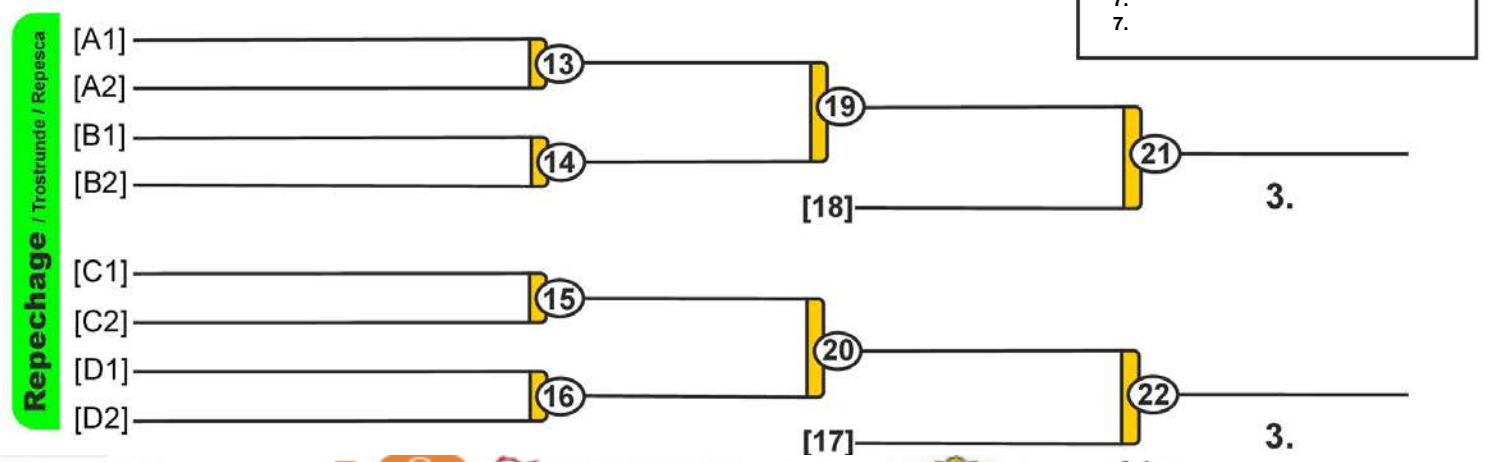

Results	
Resultat / Platzierungen / Resultados	
1.	
2.	
3.	
3.	
5.	
7.	
7.	

Super Copa de Espanya Cadete Alicante 2018

Alicante (VAL), 10 Mar 2018

-48 kg

13 Judoka

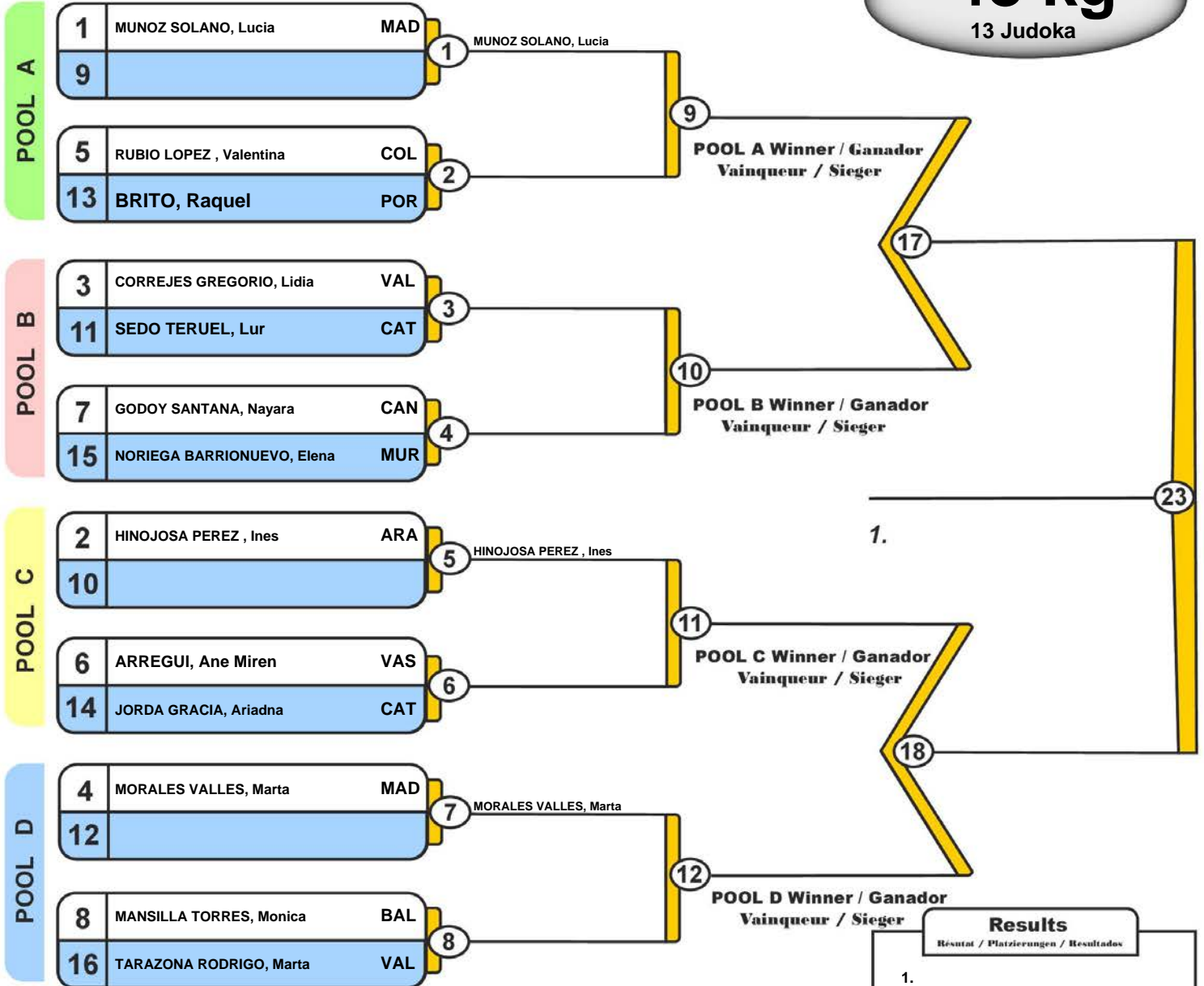

Trostrunde / Repechage / Ronda de consolación

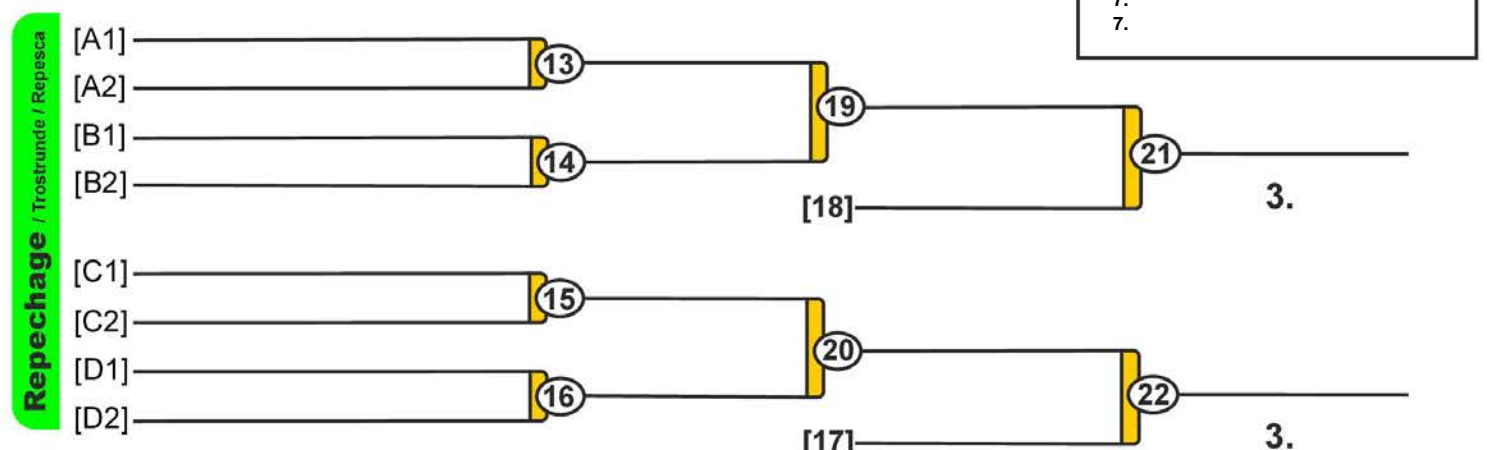

Results	
Resultat / Platzierungen / Resultados	
1.	
2.	
3.	
3.	
5.	
7.	
7.	

Super Copa de Espanya Cadete Alicante 2018

Alicante (VAL), 10 Mar 2018

-52 kg

26 Judoka

POOL A

1	CASTELLO DIEZ, Marina	VAL
17		
9	BEORLEGUI OSES, Paula	NAV
25	BONILLA ROMERO, Sara	RIO
5	BORRELL VIVES, Julia	CAT
21	VEGA MUNIZ, Valeria	CTB
13	ARRIBAS, Silvia	ARA
29	REVERT CARRASCO, Ainhoa	VAL

1 CASTELLO DIEZ, Marina

17

2

3

4

18

25

POOL A Winner / Ganador
Vainqueur / Sieger

POOL B

3	RAMIREZ GIMENEZ, Sandra	ARA
19		
11	AGUIRRE ACOSTA, Alba	MUR
27	IRIARTE FAJARDO, Irati	VAS
7	MARTIN GIL, Alicia	MAD
23		
15	PREGONAS SILVESTRE, Naia	VAL
31	HINOJOSA LARROSA, Elena	ARA

5 RAMIREZ GIMENEZ, Sandra

19

6

7

8

20

26

POOL B Winner / Ganador
Vainqueur / Sieger

POOL C

2	GARCIA MARTIN, Marta	MAD
18		
10	GALLEGO VAZQUEZ, Paula	VAL
26	ALSO MONSERRAT, Laura	CAT
6	RUBIO MORILLAS, Paola	MAD
22	HERRERA, Adriana	ARA
14	SOFIA FIALHO BRAS, Margarida	POR
30	MUNOZ LLORET, Mercedes	MUR

9 GARCIA MARTIN, Marta

21

10

11

12

22

27

POOL C Winner / Ganador
Vainqueur / Sieger

POOL D

4	JUAN MARTINEZ, Paula	MAD
20		
12	MARTINEZ LLORET, Leyre	NAV
28	RUBIO GARCIA-SOTO, Andrea	VAL
8	KONARE SISSOKO, Deniba	VAS
24		
16	SANS CARRETERO, Maria	BAL
32	NIETO BOILLOS, Luna	ARA

13 JUAN MARTINEZ, Paula

23

14

15

16

24

28

POOL D Winner / Ganador
Vainqueur / Sieger

1.

43

38

Results

Résultat / Platzierungen / Resultados

- 1.
- 2.
- 3.
- 3.
- 5.
- 5.
- 7.
- 7.

Trostrunde / Repechage / Ronda de consolación

Repechage

[A1]		29
[A2]		33
[B1]		30
[B2]		34
[C1]		31
[C2]		35
[D1]		32
[D2]		36

[A3]

[B3]

[C3]

[D3]

[38]

[37]

3.

3.

Super Copa de Espanya Cadete Alicante 2018

Alicante (VAL), 10 Mar 2018

-57 kg

32 Judoka

POOL A

1	PEREZ COLLAZO, Eva	RIO
33		
17		
49		
9	SANCHEZ MARTINEZ, Amelia	CAT
41	MOLLA SEMPERE, Eva	VAL
25	BANOS LOPEZ, Maria	MUR
57		
5	BEAUSSE SIRO, Melany	VAL
37		
21		
53		
13	RAMIREZ MARTINEZ, Marta	AND
45	QUERALTO RAMOS, Julia	CAT
29	WHORLE CEMBREROS, Sara	ARA
61		

1	PEREZ COLLAZO, Eva
33	
2	
49	
3	BANOS LOPEZ, Maria
34	
4	
57	
5	BEAUSSE SIRO, Melany
35	
6	
50	
7	
36	
8	WHORLE CEMBREROS, Sara

POOL B

3	RIBERA VERGES, Julia	CAT
35		
19		
51		
11	GIMENO TRICOT, Natasha	VAL
43	CAMPUZANO PEREZ, Maria	CLM
27	CASAS LACAMBRA, Eva	ARA
59		
7	GUTIERREZ GONZALEZ, Lara	CAN
39		
23		
55		
15	RIVERA PEREZ, Laura	ARA
47	RICO FERRANDEZ, Amaya	VAL
31	SOSA AGUADO, Marina	BAL
63		

9	RIBERA VERGES, Julia
37	
10	
51	
11	
38	
12	CASAS LACAMBRA, Eva
59	
13	GUTIERREZ GONZALEZ, Lara
39	
14	
52	
15	
40	
16	SOSA AGUADO, Marina

POOL C

2	JUAN MARTINEZ, Alba	MAD
34		
18		
50		
10	CORDERO RODRIGUEZ, Marina	MUR
42	GUERRERO DONAT, Aitana	VAL
26	DAPENA RODRIGUEZ, Patricia	ARA
58		
6	RODRIGUEZ PENA, Helena	MAD
38		
22		
54		
14	BALLESTEROS SAIZ, Noelia	VAL
46	MARTINEZ OCHOA, Carmen	RIO
30	HIDALGO, Marina	CAT
62		

17	JUAN MARTINEZ, Alba
41	
18	
53	
19	
42	
20	DAPENA RODRIGUEZ, Patricia
58	
21	RODRIGUEZ PENA, Helena
43	
22	
54	
23	
44	
24	HIDALGO, Marina

POOL D

4	RODRIGUEZ PEREZ, Angels	CAT
36		
20		
52		
12	MARTIN CORREA, Lucia	MUR
44	CAPILLA HEREDIA, Alba	VAL
28	ROSA CANO, Noelia Ana	VAL
60		
8	BORDA ZUMETA, Irati	VAS
40		
24		
56		
16	GOMEZ SANMIGUEL, Candela	VAL
48	BARTKEVICIUTE, Eleonora	AND
32	CAMERANO, Julia	ARA
64		

25	RODRIGUEZ PEREZ, Angels
45	
26	
55	
27	
46	
28	ROSA CANO, Noelia Ana
60	
29	BORDA ZUMETA, Irati
47	
30	
56	
31	
48	CAMERANO, Julia

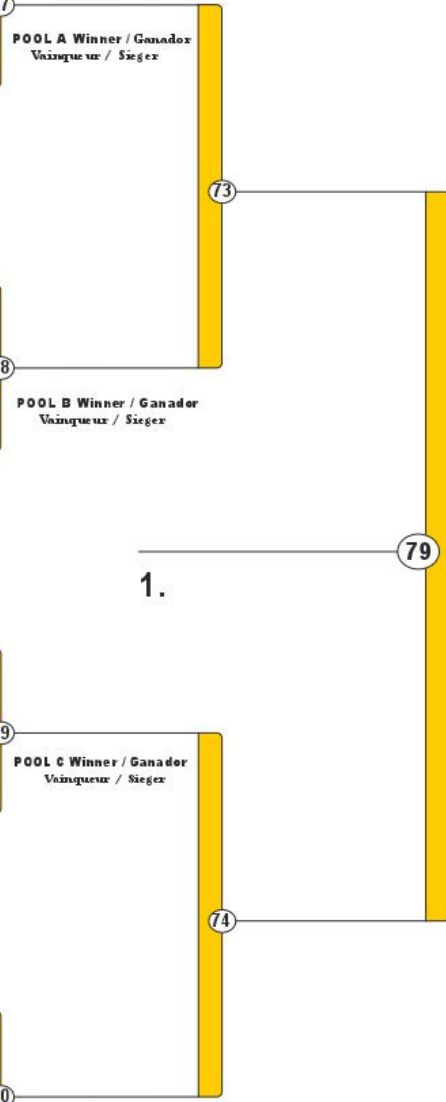

1.

Results

Résultat / Platzierungen / Resultados

- 1.
- 2.
- 3.
- 3.
- 5.
- 5.
- 7.
- 7.

Trostrunde / Repechage / Ronda de consolación

Repechage

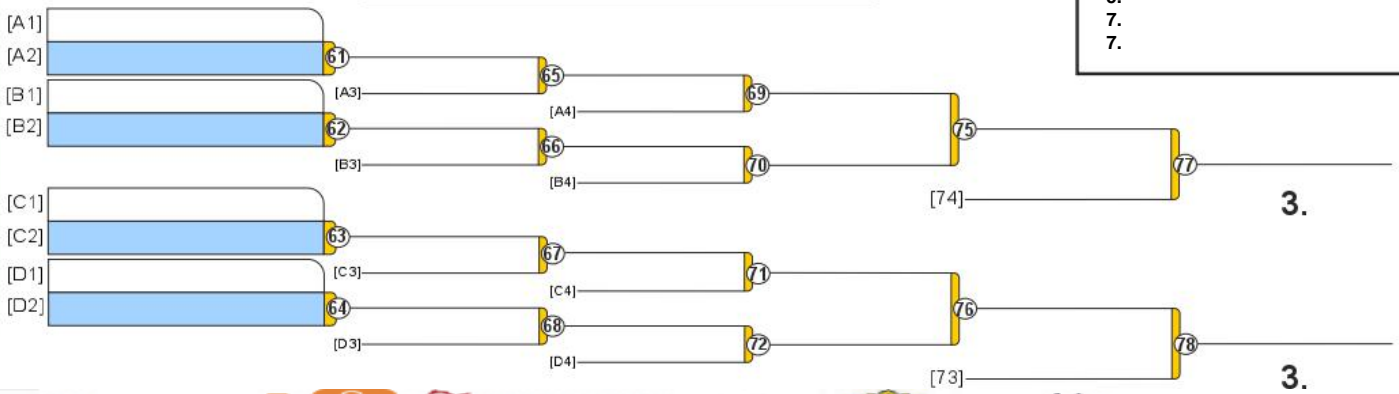

Super Copa de Espanya Cadete Alicante 2018

Alicante (VAL), 10 Mar 2018

-63 kg

22 Judoka

POOL A

1	POBLADOR SANCHEZ, Maria	ARA	1	POBLADOR SANCHEZ, Maria
33			33	
17			2	
49			3	
9			4	
41			5	PENCUE MARTINEZ, Nikol Andrea
25			5	PENCUE MARTINEZ, Nikol Andrea
57			6	TORRES EGEA, Alicia
5	PENCUE MARTINEZ, Nikol Andrea	VAL	6	TORRES EGEA, Alicia
37			7	MARTINEZ LOPEZ, Lala
21	TORRES EGEA, Alicia	BAL	7	MARTINEZ LOPEZ, Lala
53			8	MEDINA MORENO, Lucia
13	MARTINEZ LOPEZ, Lala	CAT	8	MEDINA MORENO, Lucia
45				
29	MEDINA MORENO, Lucia	VAL		
61				

POOL B

3	FUERTES AYALA, Marta	RIO	9	FUERTES AYALA, Marta
35			9	FUERTES AYALA, Marta
19			10	
51			11	
11			12	
43			13	AGUIRREZABALA YUBERO, Marta
27			13	AGUIRREZABALA YUBERO, Marta
59			14	CASTANO ENCINAS, Laura
7	AGUIRREZABALA YUBERO, Marta	VAS	14	CASTANO ENCINAS, Laura
39			15	SANCHIS FERRERO, Natalia
23	CASTANO ENCINAS, Laura	CAT	15	SANCHIS FERRERO, Natalia
55	BASTOS, Joana	POR	16	GONZALEZ RUIZ, Agueda
15	SANCHIS FERRERO, Natalia	VAL		
47				
31	GONZALEZ RUIZ, Agueda	MUR		
63				

POOL C

2	DASGUPTA, Aakriti	CAT	17	DASGUPTA, Aakriti
34			17	DASGUPTA, Aakriti
18			18	
50			19	
10			20	
42			21	RONCAL UZQUEDA, Leyre
26			21	RONCAL UZQUEDA, Leyre
58			22	LOPEZ MADEJSKA, Ana Maria
6	RONCAL UZQUEDA, Leyre	NAV	22	LOPEZ MADEJSKA, Ana Maria
38			23	GUTIERREZ MOLINA, Ashley
22	LOPEZ MADEJSKA, Ana Maria	MUR	23	GUTIERREZ MOLINA, Ashley
54			24	MARTINEZ RUEDA, Maaria
14	GUTIERREZ MOLINA, Ashley	VAL		
46				
30	MARTINEZ RUEDA, Maaria	RIO		
62				

POOL D

4	ETXEBARRIA BILBAO, Olatz	VAS	25	ETXEBARRIA BILBAO, Olatz
36			25	ETXEBARRIA BILBAO, Olatz
20			26	
52			27	
12			28	
44			29	FERNANDEZ HERRERA, Aitana
28			29	FERNANDEZ HERRERA, Aitana
60			30	SACAVEM, Carolina
8	FERNANDEZ HERRERA, Aitana	VAL	30	SACAVEM, Carolina
40			31	GAROLERA MARCOS, Lala
24	SACAVEM, Carolina	POR	31	GAROLERA MARCOS, Lala
56			32	TORRES, Valeria
16	GAROLERA MARCOS, Lala	CAT		
48				
32	TORRES, Valeria	VAL		
64				

Repechage

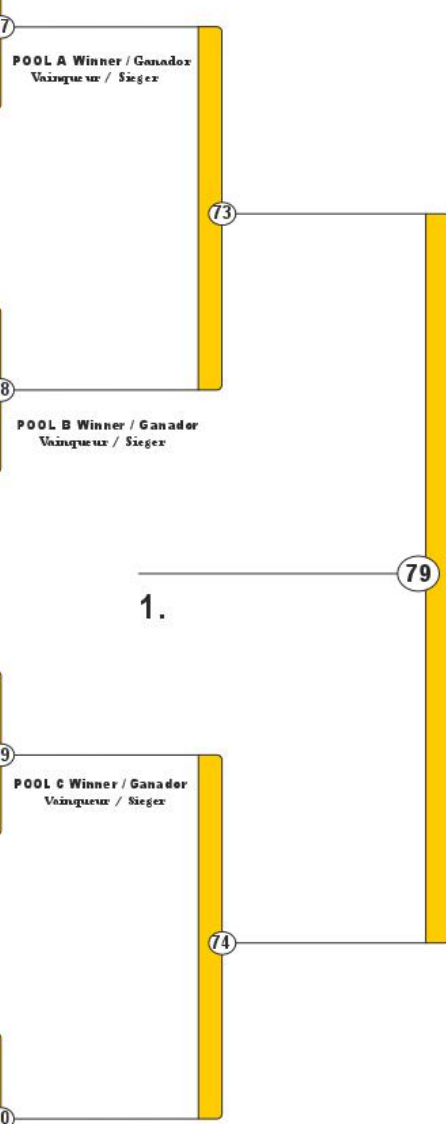
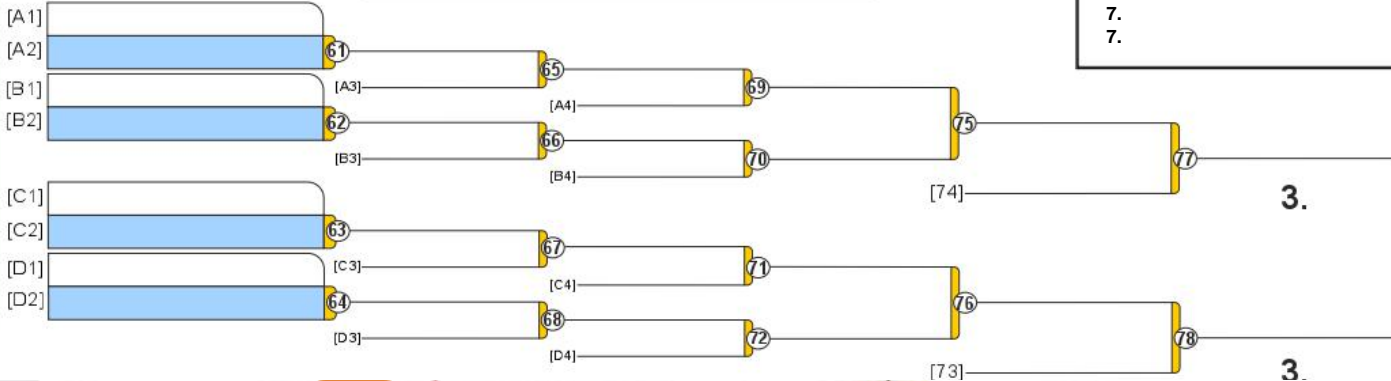

Results
Resultat / Platzierungen / Resultados

- 1.
- 2.
- 3.
- 3.
- 5.
- 5.
- 7.
- 7.

Super Copa de Espanya Cadete Alicante 2018

Alicante (VAL), 10 Mar 2018

-70 kg

12 Judoka

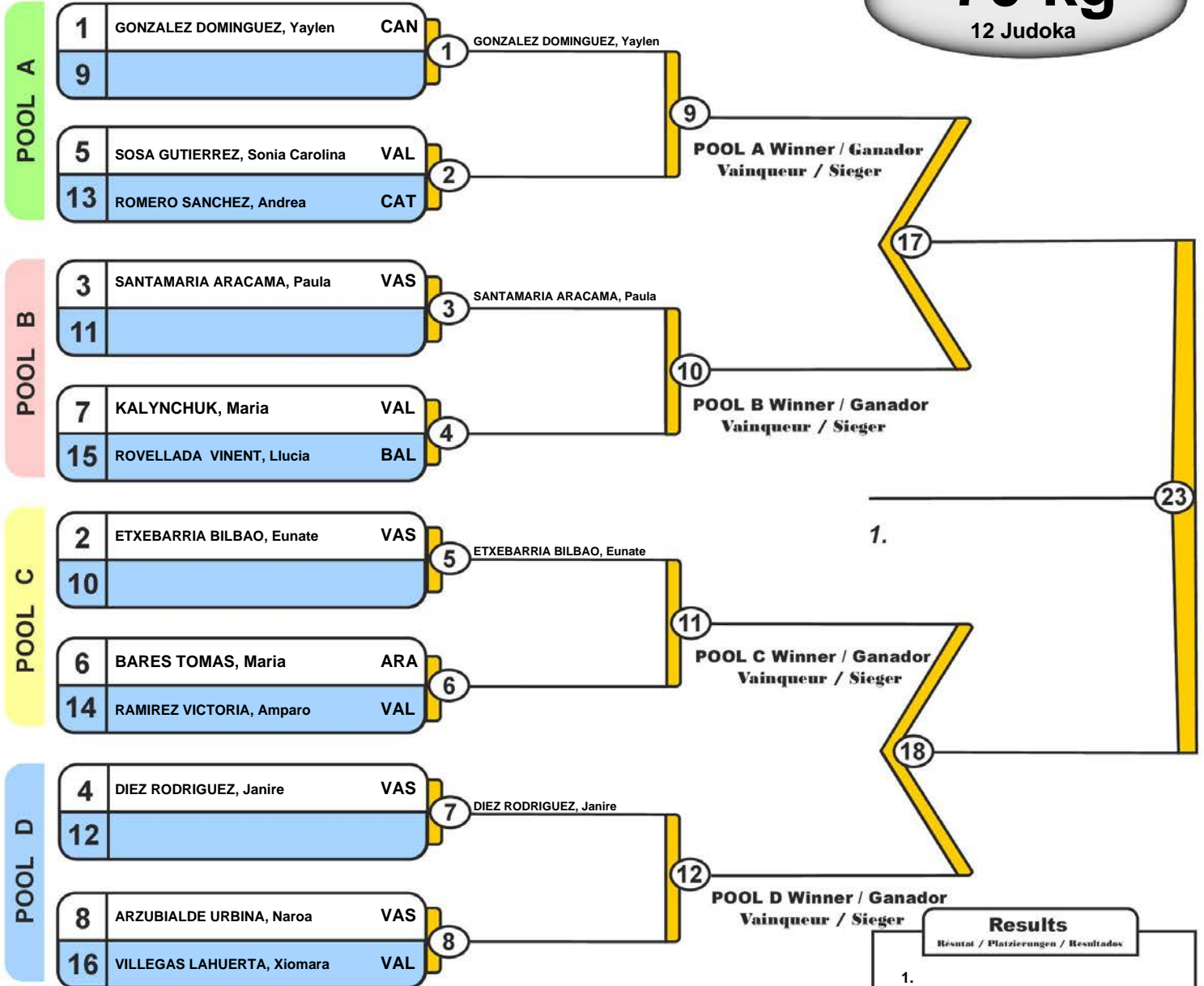

Trostrunde / Repechage / Ronda de consolación

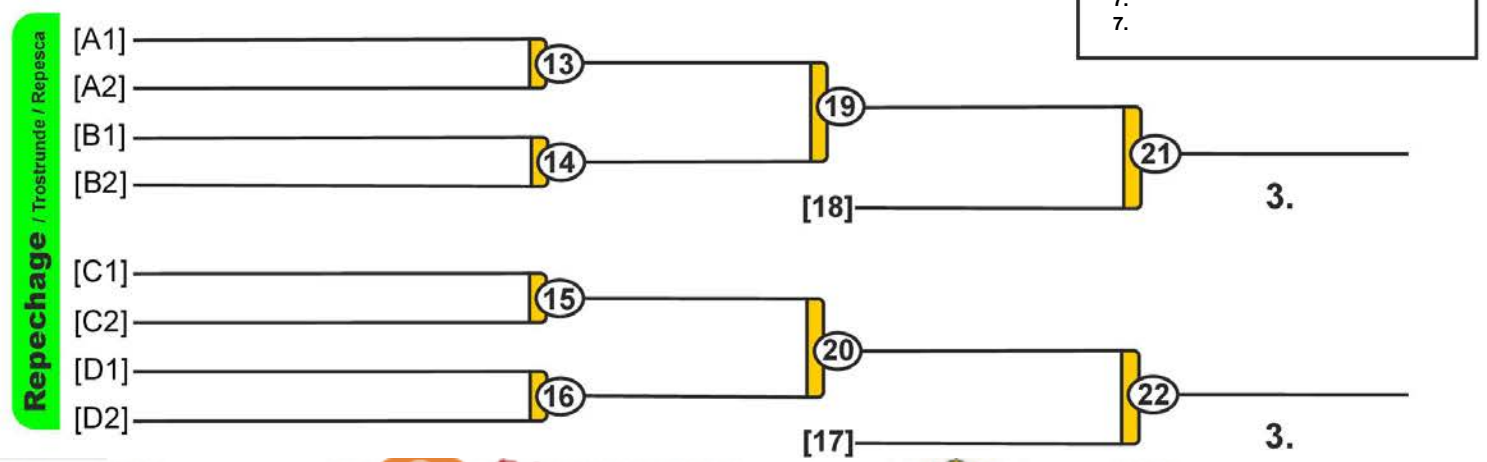

Results	
Resultat / Platzierungen / Resultados	
1.	
2.	
3.	
3.	
5.	
5.	
7.	
7.	

Super Copa de Espanya Cadete Alicante 2018

Alicante (VAL), 10 Mar 2018

+70 kg

7 Judoka

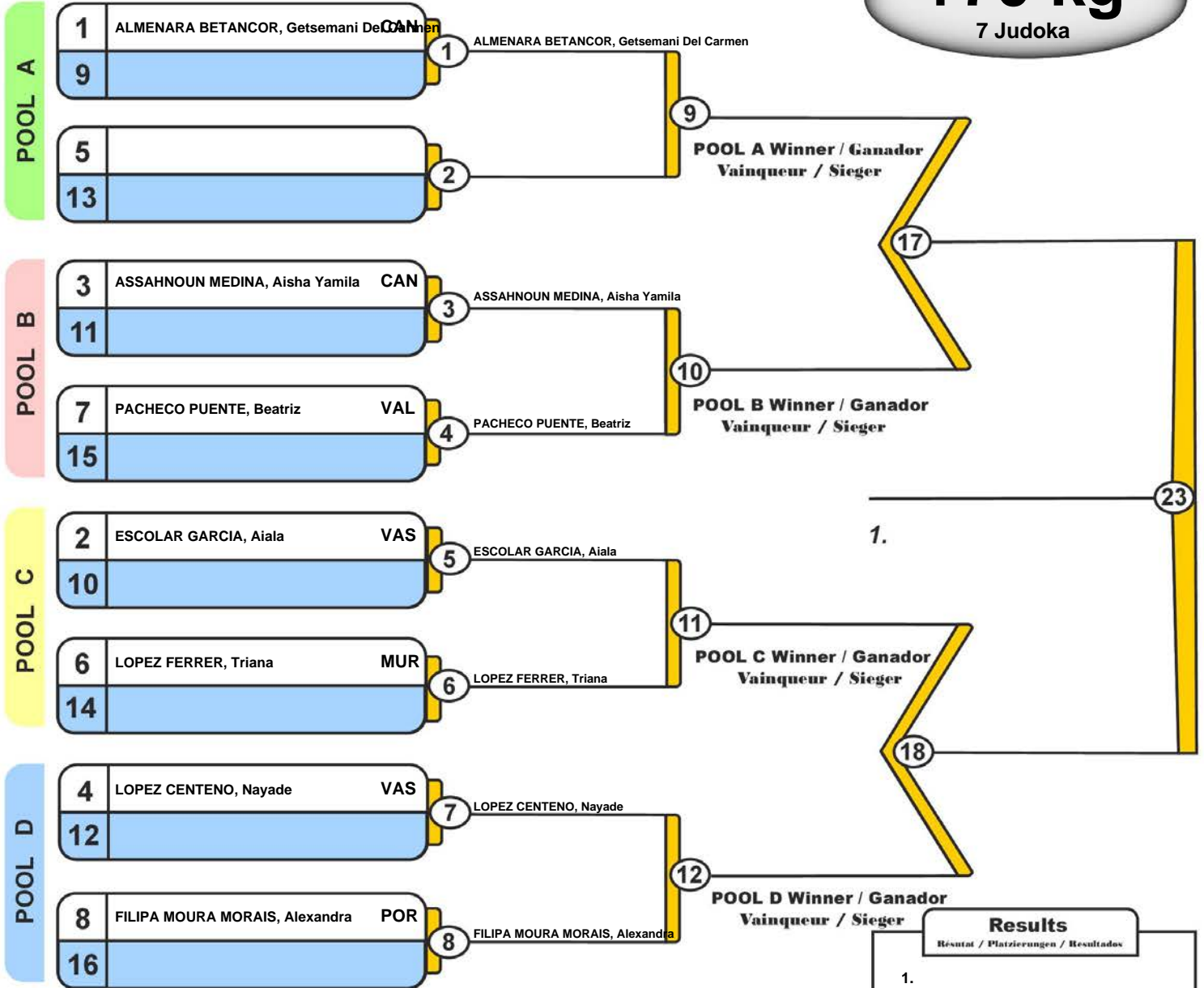

Trostrunde / Repechage / Ronda de consolación

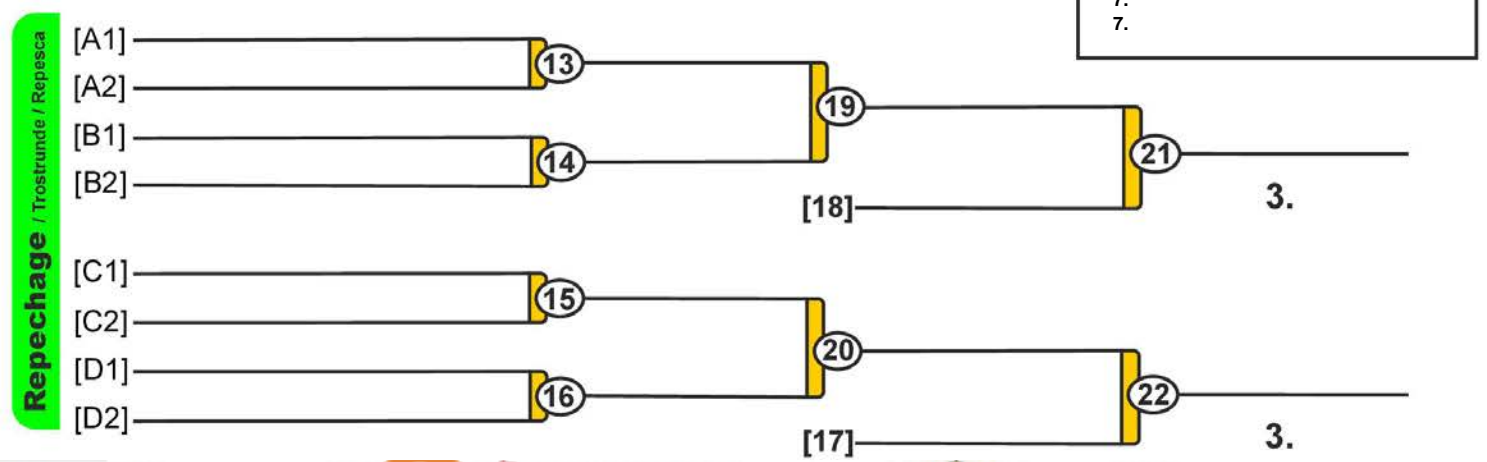

Results	
Resultat / Platzierungen / Resultados	
1.	
2.	
3.	
3.	
5.	
7.	
7.	